



December
25 Cents
Canada 30¢

Radio-Craft

HUGO GERNSBACK Editor



**BUILD THIS
UNIVERSAL PORTABLE**
See Page 336



Latest in Television—36 Watts from Type 45 Power Tubes—Pee Wee Analyzer
High Fidelity in Radio Sets—Tubeless "B" Unit for Farm Sets—3 New Tubes

Science develops a "Magic Brain" that makes All-Wave Radio actually think!

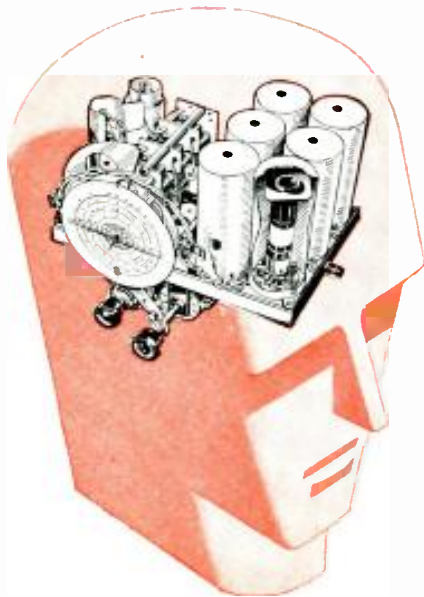

RCA Victor engineers produce uncanny governing unit in all-wave chassis that is directing force for superior long- and short-wave performance

Deep in the center of RCA Victor's new all-wave radios is placed the "Magic Brain".

It is a new and exclusive RCA Victor development that permits far greater latitude in all-wave performance. Human in its power of selection and direction of discovering signals, it can be compared to the human brain.

There are two principal engineering features which give the "Magic Brain" its outstanding performance characteristics. First, the radio frequency stage *ahead of the first detector*. RCA Victor engineers have succeeded in designing this stage so that it functions with equal efficiency on all bands. It amplifies the signal you tune, *four times*, without acting on noise, cross-talk, image frequencies or other interfering factors. Thus, the wanted signal is *supercharged*, resulting in a four-to-one signal-to-noise ratio and a practical elimination of background noise and cross-talk from the speaker output. Reproduction is clear, with a higher-fidelity tone, and freer from interference than ever before.

The second great "Magic Brain" advantage is the RCA Victor multi-coil system. A separate and distinct set of three coils act for each band—so no coil performs more than one function. Furthermore, each coil is trimmed or adjusted individually for maximum performance. In effect, then, these RCA Victor "Magic Brain" all-wave sets are really three, four or five sets in one, depending on the number of wave bands covered.

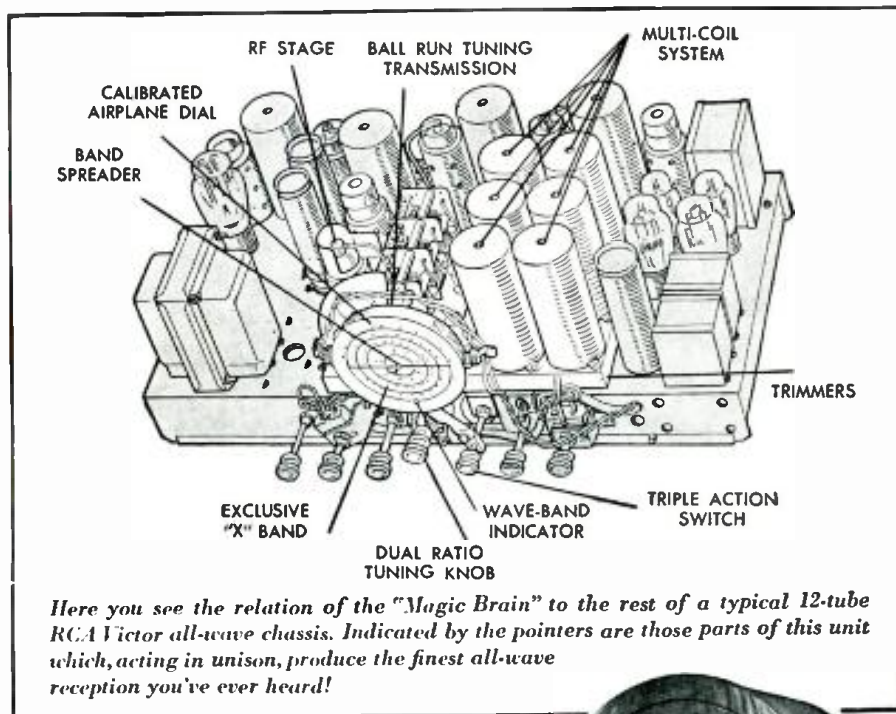

Here you see the relation of the "Magic Brain" to the rest of a typical 12-tube RCA Victor all-wave chassis. Indicated by the pointers are those parts of this unit which, acting in unison, produce the finest all-wave reception you've ever heard!

You get an enormously increased range in these new receivers—as much as 140 kc to 36,000 kc! Everything, practically, in the world of radio is yours, including the new ultra short-wave police signals. Also, in "Magic Brain" chassis of 8 tubes or better, an exclusive "X" band is provided—for hourly U. S. Government weather aviation reports.

An interesting pamphlet is offered you, free. It tells, in detail, the fascinating story of the "Magic Brain". Write today for it. Use the convenient coupon.



TABLE MODEL 128. "Magic Brain" Superheterodyne, domestic, foreign, police, \$69.95 amateur wave bands

"X" Band is in all sets of 8 tubes or more

A RADIO AND A PRICE FOR EVERYONE!
RCA Victor Instruments priced from \$14.75 to \$375, including Standard Receivers, Auto Radios, Air-Cell Battery Radios and Radio-Phonographs. All RCA Victor Instruments equipped with RCA Micro-Sensitive Radio Tubes. All prices subject to change without notice. Any short-wave radio performs better with an RCA World-Wide Antenna. Prices F.O.B. Camden, N. J.

GET THE INTERESTING ANSWERS to these "Magic Brain" Questions!

- What is the "Magic Brain"?
- Why you get higher fidelity tone?
- What are the 3 reasons for the RF stage?
- How does the multi-coil system work?
- Why is it so necessary?
- Why is high "Signal-to-noise" ratio good?
- What extra mechanical features has it?
- How wide is the KC range?

— the answers to these and many other questions are given for you in a free pamphlet. You are invited to get your copy. Use this coupon now.

RCA Victor Co., Inc., Camden, N. J. Dept. C

I'm interested in getting more details on the "Magic Brain". Kindly send me the pamphlet you mention.

Name _____

Address _____

City _____ State _____

RCA VICTOR

RCA VICTOR CO., INC., ONE UNIT OF RADIO CORPORATION OF AMERICA... THE WORLD'S LARGEST RADIO ORGANIZATION. OTHER UNITS: NATIONAL BROADCASTING CO., INC. . . . R. C. A. COMMUNICATIONS, INC. . . . RCA RADIOTRON CO., INC. . . . RADIOMARINE CORPORATION OF AMERICA

LEARN RADIO IN 10 WEEKS!

BY ACTUAL SHOP WORK ON REAL EQUIPMENT

PAY FOR YOUR TRAINING

-In Small Monthly Payments-

AFTER YOU GRADUATE

Come to Coyne now! No need to wait till you have more cash or for "better times" to get your training in the World's most fascinating, highly-paid profession. I'll train you, here at Coyne, in a practical way so that you will be prepared to take a real job and cash in quickly! . . . AND I'LL FINANCE YOUR TRAINING! Not until two months after you have graduated will you have to start to pay me back . . . then you can take a whole year to do it in easy monthly amounts. Get the particulars of this sensational plan NOW—just mail the coupon below.

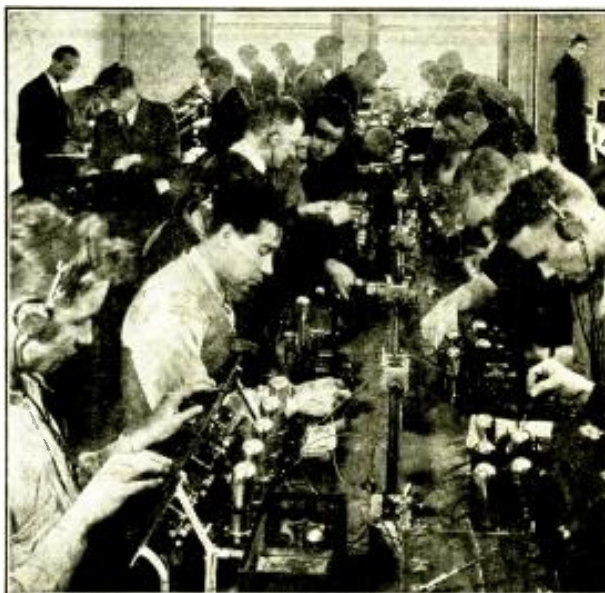

REAL OPPORTUNITIES

FOR THE RADIO TRAINED MAN

With Coyne training you will be qualified to accept a job as Designer, Inspector, or Tester—as Radio Salesman or in Service and Installation—as Operator or Manager of a Broadcasting Station—as Wireless Operator on a Ship or Airplane—as a Talking Picture or Sound Expert—or in any of hundreds of other fascinating, well-paid jobs.

TALKING PICTURES—TELEVISION

Yes, Coyne training is complete! It fits you to take an important place in these new fields that offer great opportunities for trained men, and which are being developed rapidly. Be ready for your chance in Television as well as in Sound Amplification and Radio. At Coyne you are trained on real Talking Pictures and Television equipment.

ELECTRIC REFRIGERATION — AIR-CONDITIONING

Included at NO EXTRA COST

So that you may have the kind of all-round training that increases your earning capacity, and enables you to grasp every opportunity. I am—for a limited time—including my big, new course in Electric Refrigeration and Air Conditioning. Here is a big chance for you to get practical training in a great new field at no additional cost.

NO ADVANCE EDUCATION OR PREVIOUS EXPERIENCE NEEDED

I don't teach you by book study! Your training at

H. C. LEWIS, President RADIO DIVISION Founded 1899
COYNE ELECTRICAL SCHOOL
500 S. Paulina St., Dept. 94-8H, Chicago, Ill.

Coyne comes through actual work, under the individual guidance of expert instructors, on a great outlay of Radio, Broadcasting, Television, Talking Picture and Wireless Code equipment. Because we cut out useless theory, you can get a practical training in only 10 weeks, if you can understand simple English and are sincere in your effort.

SPARE TIME WORK WHILE LEARNING

Employment Service After Graduation

If you need part-time work while at school to help pay expenses, I'll help you get it. And, when you enroll at Coyne, you get a lifetime scholarship and free employment service for life after graduation.

MAIL COUPON TODAY!

I'll Send You All the FACTS

Fill in the coupon below, and mail it to me today. As soon as I receive it, I'll send you My Big Free Book, that tells all about Coyne and contains hundreds of pictures of these great Shops, and I'll tell you all about my "Pay After Graduation Plan", and all the other features of my course.

H. C. LEWIS, President, Coyne Electrical School
 Radio Div., 500 S. Paulina St., Dept. 94-8H, Chicago
 Dear Mr. Lewis: Send me your big FREE Book; details of your FREE Employment Service; and tell me all about your special offer of allowing me to pay for training on easy monthly terms after graduation.

Name

Address

City.....State.....

Please Say That You Saw It in RADIO-CRAFT



HUGO GERNSBACK, Editor-in-Chief
 J. T. BERNSELY, Managing Editor
 C. W. PALMER Associate Editor
 R. D. WASHBURNE Technical Editor



CONTENTS OF THE DECEMBER, 1934, ISSUE

VOLUME VI

Number 6

Editorial: Radio Frauds.....	Hugo Gernsback	325
The Radio Month in Review.....		326
Radio Pictorial.....		328
Latest in Television.....	J. T. Bernsley	330
International Radio Review.....		332
The Mystery Set.....	Hugo Gernsback	334
A New Giant Loudspeaker.....		334
Berlin Radio Show.....		335
Make a Universal-Powered Arm Rest Portable	R. W. Stienmeyer	336
How to Make a Velocity Mike and Pre-Amplifier	A. Barbieri	338
The Problems in High-Fidelity Design	Wilhelm E. Schrage	339
The Latest Radio Equipment.....		340
Short-Cuts in Radio.....		342
3 New Tubes.....	R. D. Washburne	343
How to Build a Tubeless Power Supply, C. W. Palmer		344
Readers' Department.....		345
ORSMA Forum.....		346
A New Wide-Range Variable Output P.A. Amplifier	Charles R. Shaw	347
An 18-36 Watt P.A. Amplifier.....		348
Build This 5 Tube Midget Superheterodyne	Hubert L. Shortt	349
A Modern 10 Tube All-Wave Set.....	S. Miller	349
A Service Man's Pee-Wee Analyzer.....	E. J. Sampson	350
The Listening Post for All-Wave DX-ers	C. A. Morrison	351
Operating Notes.....		352
RADIO SERVICE DATA SHEETS:		
No. 127—Philco Model 200-X 10 Tube High-Fidelity Superheterodyne.....		353
No. 128—Philco Model 200-X—Circuit Aligning Procedure and Operating Data.....		356
RADIO-CRAFT'S Information Bureau.....		354

FEATURING SHORT-WAVES IN OUR NEXT ISSUE:

WE WILL devote a considerable number of pages, in the forthcoming issue, to the latest and most interesting developments in short-wave radio.

IN THE POLICE FIELD—a new and sensational miniature "personal" receiver, designed for the policeman on foot or horseback, which employs 5 special tubes so efficiently that astounding results and volume are obtained on a 3 foot length of wire for antenna.

FOR THE CONSTRUCTOR AND EXPERIMENTER: A number of complete constructional articles on short- and all-wave receiver designs which will meet with the approval of the most exacting fan. One design concerns a single-tube all-electric all-wave set—a highly efficient and economical headphone receiver. Another is a 6 tube all-wave receiver capable of extreme long-distance reception. It is designed for both broadcast listener and "ham."

FOR THE SERVICE MAN: New data on all-wave antenna design and installation. Also a thorough and complete constructional article on an all-wave oscillator; this is a real "how-to-build" story.

RADIO-CRAFT is published monthly, on the fifth of the month preceding that of date; its subscription price is \$2.50 per year. (In Canada and foreign countries, \$3.00 a year to cover additional postage.) Entered at the post office at Mt. Morris, Ill., as second-class matter under the act of March 3, 1879.

Text and illustrations of this magazine are copyright and must not be reproduced without permission of the copyright owners. We are also agents for WONDER STORIES and EVERYDAY SCIENCE AND MECHANICS. Subscription to these magazines may be taken in combination with RADIO-CRAFT at reduced Club rates. Write for information.

Copyright 1934. Continental Publications, Inc.

HUGO GERNSBACK, President I. S. MANHEIMER, Secretary
 Published by Continental Publications, Inc. Publication office: 404 N. Wesley Ave., Mount Morris, Illinois. Editorial and Advertising Office: 99 Hudson Street, New York City. Chicago Advertising Office: L. F. McClure, 919 North Michigan Avenue, Chicago, Ill. Western Advertising Office: Loyd B. Chappell, 511 So. Alexandria St., Los Angeles, Calif.

London Agent:

Hachette & Cie., 3 La Belle Sauvage, Ludgate Hill, E.C. 4
 Paris Agent: Hachette & Cie., Australian Agent: McGills Agency
 111 Rue Reamur 179 Elizabeth St., Melbourne



J. E. Smith, President National Radio Institute

Be a Radio Expert

Many make **\$40 \$60 \$75** a week

I will train you at home for many Good Spare Time and Full Time Radio Jobs

SET SERVICING
Spare time set servicing pays many N.R.I. men \$5, \$10, \$15 a week extra. Full time men make as much as \$40, \$60, \$75 a week. Almost every community offers trained men opportunities to enter this profitable field.



If you are dissatisfied with your present job; if you are struggling along in a rut with little or no prospect of anything better than a "skinny pay envelope—clip the coupon NOW. Get my big FREE book on the opportunities in Radio. Read how quickly you can learn at home in your spare time to be a Radio Expert—what good jobs my graduates have been getting—real jobs with real futures.

REAL OPPORTUNITIES AHEAD IN RADIO FOR TRAINED MEN

It's hard to find a field with more opportunity awaiting the trained man. Why. In 1933—one of the worst depression years—the Radio industry sold \$213,000,000 worth of sets and parts. Radio set sales increased 145% in sales increased 27%. Over 500,000 people worked in the industry. It's a gigantic business, even in the worst business years. And look what's ahead! Millions of sets are becoming obsolete annually. 175,000,000 sets are in operation in which over \$200,000,000 are spent each year for repairs, servicing, ray tubes, etc. Broadcasting stations pay their employees (exclusive of artists) approximately \$1,000,000 a year. Advertisers pay for broadcast-time stations over \$75,000,000 a year for radio time and talent. A few hundred \$40 \$60 \$75 a week jobs have grown to thousands. These figures are so big that they're hard to grasp! Yet they're all true! Here is a new in-

dustry that has grown to a commercial giant! No wonder business leaders predict a brilliant future for this great and growing business!

GET INTO THIS FIELD WITH A FUTURE

There's opportunity for you in Radio. Its future is certain. Television, short waves, police Radio, automobile Radio, pocket sets, loud speaker systems, aviation Radio—in every branch developments and improvements are taking place. Here is a real future for hundreds of men who really know Radio. Get the training that opens the road to good pay and success! Send the coupon now and get full particulars on how easy and interesting I make learning at home. Read the letters from graduates who are today earning good money in this fascinating industry.

MANY MAKE \$5, \$10, \$15 A WEEK EXTRA IN SPARE TIME WHILE LEARNING

My book proves that many of my students make \$5, \$10 and \$15 a week extra servicing sets in spare time while learning. I give you plans and ideas that have made good spare time money—\$200 to \$1,000 a year—for hundreds of fellows. My Course is famous as "the one that pays for itself."

MONEY BACK IF NOT SATISFIED

I am so sure that N. R. I. can train you at home satisfactorily that I will agree in writing to refund every penny of your tuition if you are not satisfied with my lesson and instruction Service upon completion. You'll get a copy of this Agreement with my book.

64-PAGE BOOK OF FACTS FREE

Get your copy today. It's free to any ambitious fellow over 15 years old. It tells you about Radio's spare time and full time job opportunities; it tells you all about my Course; what others who have taken it are doing and making. Find out what Radio offers YOU! without the slightest obligation. MAIL THE COUPON in an envelope, or paste it on a 1c post card NOW.

J. E. SMITH, President
NATIONAL RADIO INSTITUTE, Dept. 4NX
Washington, D. C.



BROADCASTING STATIONS

employ managers, engineers, operators, installation and maintenance men for jobs paying up to \$5,000 a year. The larger stations employ as many as 20 to 60 men. Over 600 Broadcasting Stations now in operation.

LOUD SPEAKER APPARATUS

Installing, servicing Loud Speaker Systems in auditoriums, for sporting events, political rallies, in schools, factories, etc., is another growing money-making field for which N.R.I. will train you.



FREE: Radio Servicing Tips

Let me PROVE that my Course is clear, easy to understand and fascinating to study. Send the coupon for a free lesson, "Trouble Shooting in D.C., A.C., and Battery Sets."



This interesting lesson gives 192 ways to correct common Radio troubles. I am willing to send this book to prove that you too can master Radio—just as thousands of other fellows have done. Many of them, without even a grammar school education, and no Radio or technical experience, have become Radio experts and now rate two or three times their former pay. Mail the coupon now.



TELEVISION

The coming field of many great opportunities is covered by my Course. Already there are Television Stations on the air—and Television receivers are soon to be introduced. Get ready now!

AVIATION RADIO

Radio is making flying safer. N.R.I. graduates have been given good jobs on the ground and in the air, operating and maintaining radio equipment. Radio operators employed through Civil Service Commission earn \$1,800 to \$2,500 a year.



RADIO FACTORIES

employ hundreds of Radio engineers—inspectors—testers—servicemen—mechanics—salesmen—factory foremen—paying up to \$7,500 a year. There are about 50 makers of Radio sets and 3,000 makers of parts for sets.



This Coupon is Good for One FREE Copy of My Book

J. E. SMITH, President, National Radio Institute, Dept. 4NX, Washington, D. C.

Dear Mr. Smith: With it oblig then, send me the Service Manual and your free book about spare time and full time Radio opportunities, and how I can train for them at home in spare time. (Please print plainly.)

Name Age

Address

City State

Please Say That You Saw It in RADIO-CRAFT



The 1935 Manual—

1,000 PAGES

but only an 1 1/4" thick*

NO other radio book in history is comparable to the 1935 OFFICIAL RADIO SERVICE MANUAL. In contents, in style of printing, in grade of paper, in illustrations, there has never been published such a comprehensive volume.

★ The 1935 Manual contains over a thousand pages—yet it will be only 1 1/4 inches thick because it will be printed on a special Bible stock which is an exceptionally good stock, yet one of the thinnest and most durable papers. This new Manual will be voted as the most authentic and elaborate service guide ever used in the radio industry. Service Men and dealers who use this 1935 Manual will be astonished by finding in it such a wealth of profitable service information which has never been previously made available.

Contents Reveal Important Chapters in the Contents of the 1935 Manual

- Over 1,000 pages full of diagrams and essential information of manufactured receivers—only data of real use in servicing is included. This new Manual is really portable since it will be extremely thin and light as well.
- Volume V continues where the preceding manual left off—none of the circuits published have ever appeared in any previous volumes of the OFFICIAL RADIO SERVICE MANUALS.
- Many circuits of extremely old sets not previously available are included.
- Service Men know every radio set has certain weak points which are really the cause of trouble. Wherever the information could be obtained, these weaknesses with their cures are printed right with the circuits. This is an entirely new and valuable addition to the Manual.
- All the latest receivers are included— all-wave sets, short-wave sets, auto-radio sets, midget and clear-box sets, etc., as well as P. A. amplifiers and equipment, and commercial testing and servicing instruments.
- The cumulative index is even more complete than before; including cross-reference to sets sold under different names and type numbers identical with circuits printed in this or previous volumes.
- Volume V includes resistance data; socket layouts; I. F. data; voltage data; color codes of wiring, cables, etc.; and the purpose of each tube in the set is clearly indicated on the diagram.
- Tube data on latest tubes and all previous types will be included to facilitate servicing.
- Free question and answer service—as included in our last three manuals.

Three Big, Special Offers—See Coupon

In the coupon below will be found the same three special offers as they appeared in our recent circular. Here is the last opportunity for you to save a few dollars by taking advantage of our PRE-PUBLICATION OFFER—BUT YOU MUST ORDER NOW before the book is published—about November 15. Check the offer in the coupon most convenient to you and mail it to the publishers today. DON'T DELAY!

OVER 1,000 PAGES

Over 3,000 Illustrations. Flexible, loose-leaf covers
Size 9 x 12 inches - yet only 1 1/4 inches thick

GERNSBACK PUBLICATIONS, Inc.
99 Hudson Street New York, N. Y.



SET SERVICING

Authentic service information found in the 1935 Manual of a thousand pages covers all types of radio receivers in use today. The material will be extremely valuable to every Dealer and Service Man. On the diagrams of the receivers, wherever possible, appear voltage readings of tubes, socket connections, intermediate frequencies, transformer data, alignment details, common causes of trouble and other valuable service notes.

PUBLIC ADDRESS

The many pages on new, outstanding developments in Public Address Installation and Service will be found helpful to Service Men and P. A. specialists. Such prominent features as class A and B amplifiers—single and dual channel systems—attenuators, and mixers—super-power stages—pre-amplifiers and other commercial devices available for public address and call work, will be found in this complete reference volume.

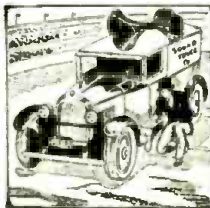

ALL-WAVE RECEIVERS

Information relative to short waves have found their way into the 1935 by popular demand. The numerous all-wave receivers now being sold by practically all the large radio set manufacturers are included. For these sets, wherever possible, complete aligning details for all wave bands are included in addition to the service material listed for other sets.



AUTO-RADIO RECEIVERS

No service manual could be complete without a section devoted to auto-radio. All available service information on new auto-radio sets has been included. From this section alone Service Men could derive sufficient knowledge to venture in a specialty field—that of servicing only auto-radios. It is one of the biggest opportunities in radio today.



CLIP THIS COUPON AND MAIL TODAY!

GERNSBACK PUBLICATIONS, INC. RC-1234
99 HUDSON ST., NEW YORK, N. Y.

Gentlemen—Herewith is my remittance for \$..... to cover the pre-publication price for one copy of the 1935 OFFICIAL RADIO SERVICE MANUAL, the regular price of which Manual is \$7.00. I have marked in the square below the offer chosen. It is distinctly understood by me that should this Manual be offered for sale within a year by a reputable mail-order house or dealer for less than this amount, you will return the difference to me.

I understand that the new Manual is to be published about October 15th.

On all three offers the postage is prepaid the publishers. This is an additional saving for you.

OFFER NO. 1
 I enclose \$5.00 in full (during the month of September, 1934), for the total price of the 1935 Manual. This saves me \$2.00.

OFFER NO. 2
 I enclose \$3.00 now (during the month of September, 1934). I will pay the postman \$3.00 when the 1935 Manual is delivered. This saves me \$1.00.

OFFER NO. 3
 I enclose \$6.50 now (during the month of September, 1934), and I am to get FREE, a one-year subscription to RADIO-CRAFT Magazine. This saves me \$3.00.

NAME

ADDRESS

CITY STATE

(Remittance should be made in U. S. or International Money Order; we also accept personal checks. If you remit in cash, or should you send new and unused U. S. postage stamps, which we also accept, be sure to register your letter.)

Please Say That You Saw It in RADIO-CRAFT



"Takes the Resistance out of Radio"

RADIO FRAUDS

An Editorial by HUGO GERNSBACK

THERE have appeared, in the past, many radio gadgets that were out and out frauds. Usually, these small appliances are sold as attachments for the radio set which are supposed to accomplish all kinds of wonders.

Chief among such frauds are static eliminators, which are usually made by some small get-rich-quick manufacturer who conceives and produces a neat little device with two binding posts and containing some type of condenser, adjustable or otherwise. It is palmed off through cheap mail order ads or through street offers "to positively kill all static." Needless to say, such devices do not work and do not eliminate static.

Other similar devices, which usually contain a cheap variable condenser made of cardboard and tinfoil, are hawked about supposedly for doing away with man-made static. These devices are mostly demonstrated on the street; a generator or other noise producing apparatus being operated in the automobile, and the radio, mounted over the radiator of the car, gives off a fearful amount of noise. Next, a glib tongue salesman will put his "static eliminator" in the aerial circuit and, lo and behold! there is no more static. This demonstration usually impresses a lot of people who buy one of these gadgets only to find when they get home and hook up the "eliminator" that the noise in their receivers is there just the same as before! The explanation is that the street fakers, when demonstrating, by some mechanical arrangement automatically disconnect the noise producing generator from the radio set and short-circuit it so that little man-made static finds its way into the radio set. Many ingenious devices are used to accomplish the purpose. Sometimes the aerial is attached to an automatic reel which makes contact inside the car where no one can see it. Another device is foot- or hand-operated, and there are many similar variations.

Then we have another device which the hawker guarantees will bring in DX as well as local stations by eliminating the aerial entirely, in addition to all noise and static. While some of these devices are not "complete" fakes, a lot of them are sold under misrepresentation, and usually do not accomplish that which the glib manufacturer specifies in his literature. Such devices usually contain a condenser of some sort and sell from \$1 up; they operate on the same principle as the light socket antenna. While they may work to a certain extent, in some instances, they certainly are not as efficient as a regular antenna; for instance on short waves they are a total loss.

While these devices may be termed harmless—because the only thing they do is to hit the pocketbook of the victim—they are not really important—though still serious.

But I do wish to emphasize some of the most dastardly frauds that are being perpetrated from time to time on the public. I refer to the disguised "radio" apparatus which is supposed to cure every disease from cancer down to a simple headache and colds! I have, from time to time, exposed some of these devices, and intend to continue to do so in the future. I have before me a circular, the title

and subject of which is "Radionics—Hope for the Sick." On the cover, the pamphlet states, "No Drugs, No Medicine—Wrong Vibrations Make You Sick; Right Vibrations Make You Well." The illustration shows "something" that looks like a large radio cabinet with many dials. The victim who falls for this sort of insanity is examined by means of applicators to which are attached flexible wires, which, in turn, are connected with the fake radio apparatus. Various meters are supposed to give an indication of the various diseases that a man is afflicted with.

When the layman sees an indicating meter, and notices that by applying two electrodes to certain parts of his body a certain reading is obtained and a different reading from other parts of the body, he is impressed because he will draw the inference that the machine or apparatus indicates on the meter what is wrong with him and gives a correct diagnosis. Needless to say, every radio man knows that there is such a thing as "ohmic resistance" of the human body. He knows that if you take a voltmeter and a battery and connect the body in series, different parts of the body will give different readings simply because of body resistance to the current flow. If you place two wires close together on the skin you will get one reading. If you place them further apart you will yet get another reading.

If the skin is dry, you get one set of readings. If the skin is damp, moist, or wet, you will get a half-dozen others. The layman does not know this, and is much awed by the technical jargon and gibberish that the fake medical practitioner tells him, and he will implicitly believe in the diagnosis which the quack so makes. If the quack is shrewd and gives the patient an examination, he may sometimes guess at what is wrong, and might thus give a diagnosis without ever having recourse to the "radio" machine. But by giving the victim a treatment by an expensive and mysterious looking apparatus, he can naturally extract a few more dollars from him than an ethical doctor will charge. In other words, the quack masquerades under the guise of a specialist because of this "special" equipment. It is needless to say that these radionic examinations are out and out fakes. You might just as well hook an ordinary radio set, an electrical bell, or your vacuum cleaner to your body and you would get exactly the same results.

Also, it is needless to add that the person who places himself in the hands of such quacks very frequently gets such wrong information that it may cost him his life because of a wrong diagnosis. In addition, the victim is fleeced of a goodly sum of money, for which he gets nothing in return excepting a misleading diagnosis that means absolutely nothing.

I would be pleased to receive any circulars or printed matter on fake devices of this kind which disguise radio, or near-radio apparatus. RADIO-CRAFT will turn them over to the responsible authorities in order to stop this vicious and pernicious habit of fleecing the public by such fraudulent methods.

THE RADIO MONTH



One of two floors of the gigantic radio show in New York.

"POST-MORTEM" ON THE RADIO SHOW

WITH THE exception of the usual complaint experienced whenever the radio and electrical industries combine to "put on a show," the recent exposition in the Madison Square Garden in New York, was markedly successful. This complaint, which we pointed out in connection with the 1933 show (RADIO-CRAFT, December 1933, page 330) is the necessity for literally climbing over electrical refrigerators, sewing machines, washers and air conditioning plants, in order to find the radio sets.

But aside from this, a very healthy atmosphere (as far as business in the coming season is concerned) pervaded the entire show. Console cabinets of the more expensive types were displayed and less of the midget and table models were seen in the new models of all manufacturers than were in view last year. The cigar-box midgets were conspicuous by their absence.

All this indicates, of course, that radio manufacturers are looking up, for the coming season, for calls for more expensive sets—and we assume that they have made this decision after a careful survey of inquiries, etc. during the past months.

All-wave sets, using trick dials took the giant share of interest displayed by the radio public. It was also interesting to notice the attention given to the "Crystal Studio" whenever that attraction was in use—at times it seemed as if the entire audience descended in a body to the front of those plate glass windows to see and hear the broadcasts which were being made. Apparently, there is still a considerable radio audience that is curious "to see how it is done," in spite of the efforts of the NBC and CBS to satisfy the incessant demand for studio passes.

A COLD RADIO TUBE

IF REPORTS from a well-known radio research laboratory on the Pacific coast can be relied upon, we may now expect to have radio tubes which do not require a filament or heater, but operate "cold." As every radio technician knows, this is one of the most sought after inventions in radio.

According to the reports received by RADIO-CRAFT last month, the new tube, a development of Philo T. Farnsworth, is an excellent oscillator or generator of radio waves and was used successfully in a recent transmission test between San Francisco and Hawaii and ships on the Pacific Ocean.

The magic bulb is described as resembling a fruit jar and has neither filament nor grid. It operates without heat and is called a "cold" tube. Electrons, tiny particles of electricity, bouncing at high speeds inside the jar do the trick.

The engineers explain that a multiplying action of the tube gained by breaking up the electronic streams into additional streams of electricity causes the oscillations, which set the ether in vibration. The tube demonstrated was rated at 500 watts output. It is used in conventional radio circuits and may be made in larger sizes to supply more power, if desired.

While the experiments with this new tube have been limited to transmitters, up to this time, we are optimistic enough to expect that the same principles may be applied to receiving circuits in the near future.

Below—The appearance of the cold tube in an experimental set-up. Right—Notice the complex system of aeriels erected on the *Norsaga*.

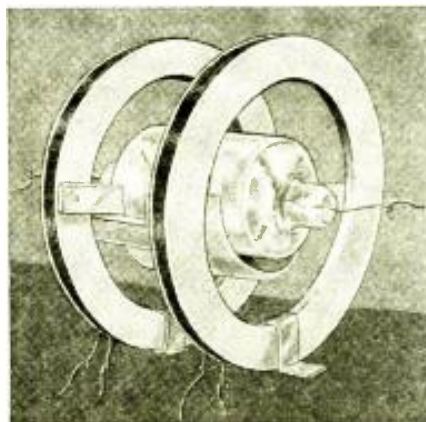

BROADCASTING THE AMERICA CUP RACES

THAT sporting event of the month—the International Cup Races—which took place off Newport, R. I. last month, may have been "a competition with primitive means of marine transportation" to the distinguished yachtsmen involved. But it was a difficult and important assignment to the engineers who fitted up and operated the radio equipment on the diesel yacht *Norsaga*.

This 110 foot ship had the task of supplying all press information as to the progress of the races for the newspapers of the world and, in addition, was one of the key points from which the broadcasts of the event took place. One has only to glance at the multiplicity of radio antennas to realize that there was plenty of radio activity below decks.

In the after cabin were two short-wave telegraph transmitters connected to automatic tape senders capable of speeds up to 200 words per minute. One transmitter was assigned to handle messages to American addresses, while the signals from the other automatically operated high-power transmitting stations at Rocky Point, L. I. The operators on board this ship were thus in direct control of the stations on land.

Announcers and engineers of the NBC occupied the forward cabin, which was equipped with their special broadcasting gear. For this purpose a short-



IN REVIEW

Radio is now such a vast and diversified art it becomes necessary to make a general survey of important monthly developments. RADIO-CRAFT analyzes these developments and presents a review of those items which interest all.

wave transmitter, a short-wave receiver and an ultra-short wave receiver were employed. The 50 watt short-wave transmitter was used to send the comments of announcers on the *Nor-saga* to the mobile station on land, and the short-wave receiver received the broadcasting cues from the same mobile station, which passed the program on to the New York studios.

The ultra-short wave receiver was employed to receive reports from the committee boat *Wilhelmina*, and when it was desired to have announcements from that vessel broadcast, an ultra-short wave receiver was connected to the transmitter of the mobile unit.

It is interesting, in concluding, to look back to 1899 when radio first entered the International Yacht Races. In that year, Marconi reported the results of the races to American newspapers also by means of a radio equipped yacht.

AMATEURS GET THEIR MAN IN TWO HOURS

THIS is a story of how several amateur radio operators in cooperation with the police located a man touring the southern states in a car, within the short time of two hours.

Charles A. Rathkopf, a prominent lawyer, urgently required to contact his son, also a lawyer, in connection with pressing business affairs, one day last month.

The son, Arden Rathkopf, and his wife had left their Lynbrook, Long Is-

land, home for a motor trip in the south. The elder Rathkopf telephoned the Lynbrook police as a last resort in locating his son. The matter was referred to the Nassau police who asked Theodore A. Bedell, operator of amateur station W2BXO at Merrick, L. I., to broadcast a description of Arden Rathkopf and his blue automobile. The message was sent out and picked up by a score of amateurs in the southern states and in less than 2 hours, a policeman in Birmingham, Ala., stopped young Rathkopf and delivered the desired message.

Once again, amateur radio has served a useful purpose. And in addition, this possibility of close cooperation between the police departments and amateurs, opens up new fields of usefulness which they might serve.

MORE JOBS IN THE FCC.

THE Federal Communications Commission which recently took over the reins of the radio, telephone, and telegraph industries has one accomplishment to its credit so far, which is deserving of praiseworthy comment. When this Commission was originated by an act of Congress earlier in the year, it was stated that it would consist of seven Commissioners.

However, this did not take into account the large amount of work necessary to maintain such a control—and when the divisions of the Commission were organized last month it was found that a total of 551 men would be needed, not counting the legal Depart-



Two of the Commissioners of the Federal Communications Commission—E. O. Sykes and Thad H. Brown.

ment or the examiner's unit, which sections have not yet been organized.

Thus, the formation of this wide-reaching group has created employment for more than 500 people, many of whom are technically trained radio men.

The first task of the Broadcast Division has been the investigation of the report requested by Congress "to study the proposal that Congress by statute allocate fixed percentages of radio broadcasting facilities to particular types or kinds of non-profit radio programs or to persons identified with particular types or kinds of non-profit activities."

The effects of this investigation and report to Congress can be easily seen. If passed, radio listeners will receive a certain percentage of programs free from the scourge of advertising. In one respect, this should increase the interest shown in the reception of entertainment via radio.

On the other hand, though, it must be remembered that broadcasting is supported by the advertisers who sponsor the programs. If part of this revenue is cut off from the broadcasters, what effect will this have on the quality of material that they send out? Will it inflict hardships that will materially affect the industry, as claimed by certain large broadcasting interests?

Another interesting side light on this investigation is the possibility that American listeners will be taxed to defray the expenses of broadcasting these "advertising free" programs.



Left—The two short wave transmitters for sending press reports on the race. Below—The sequence of incidents in locating a man by amateur radio.



RADIO PICTORIAL

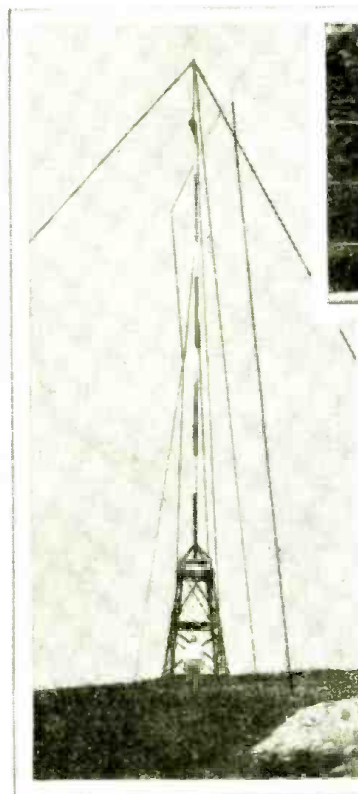

DIRECTIONAL antennas seem to have been the specialty of station KYW. Since they moved to "Philly" they have advanced the design of their "Power Booster Antenna" and are now erecting a 4-tower system which not only has advantages in focusing the power in one general direction, but also reduces the sky wave to a very small value, thus preventing interference with other stations.

Westinghouse photo.

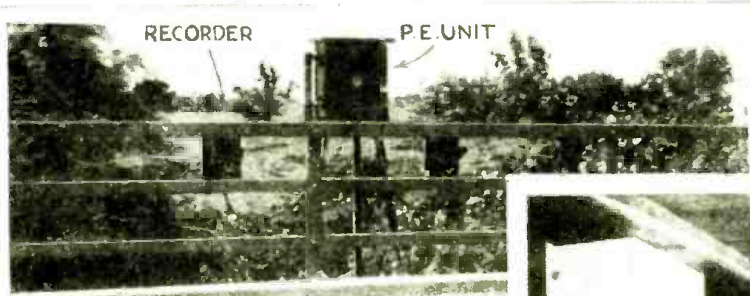

HERE'S another one for the photo-cell enthusiast—counting automobiles individually before they cross a toll bridge. A double beam of light is used to prevent false readings.

G.E. photo.

PREVENTING accidents in large motor busses is the latest use to which electronic devices have been put to in Germany. A mike is placed at the rear of the double-decker bus and sound waves from vehicles in the rear (horns, etc.) are amplified and projected in the driver's booth by means of the loudspeaker shown at the right.

A new innovation has arrived in London, whereby "Milady" can have her permanent wave without heavy, annoying wires attached to her head. Below. A high frequency (electronic) generator supplies the required heat.

Typical Press photo.

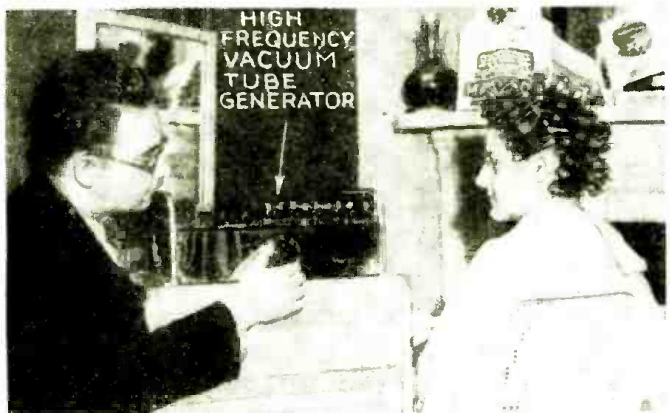
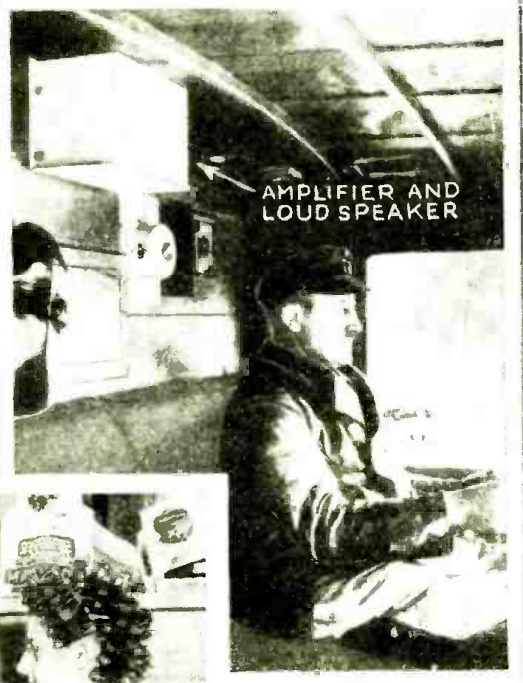

BELOW are two interesting photos of the exhibits of the New York Museum of Science and Industry at the New York Radio Show. The one at the right is a demonstration of the grid-glow effect with a grid-glow relay tube; a special sort of neon tube which ionizes by an increase in capacity of the grid. The one at the left is a photo cell siren using a perforated disc which breaks up a beam of light.



POLICE auto radio has developed by leaps and bounds during the past year. The use of the 5-meter band has permitted the radio patrolmen to talk back as well as receive instructions, but this has been limited, up to now, to separate transmitting and receiving circuits. In other words, it was necessary to throw a switch from "trans-

mit" to "receive" in order to talk or hear. With this new development, communication has been made as simple as the ordinary telephone. An ordinary "French type" phone is used as shown in the photo above. It is interesting to note that the rear bumper is used as the antenna of the system.

G.E. photo.

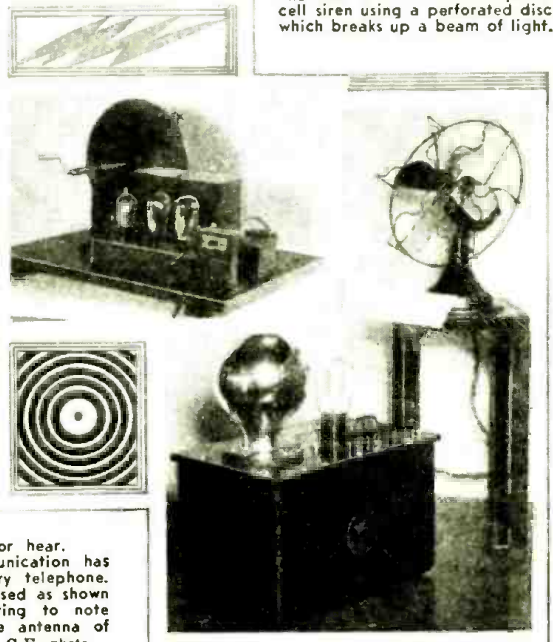

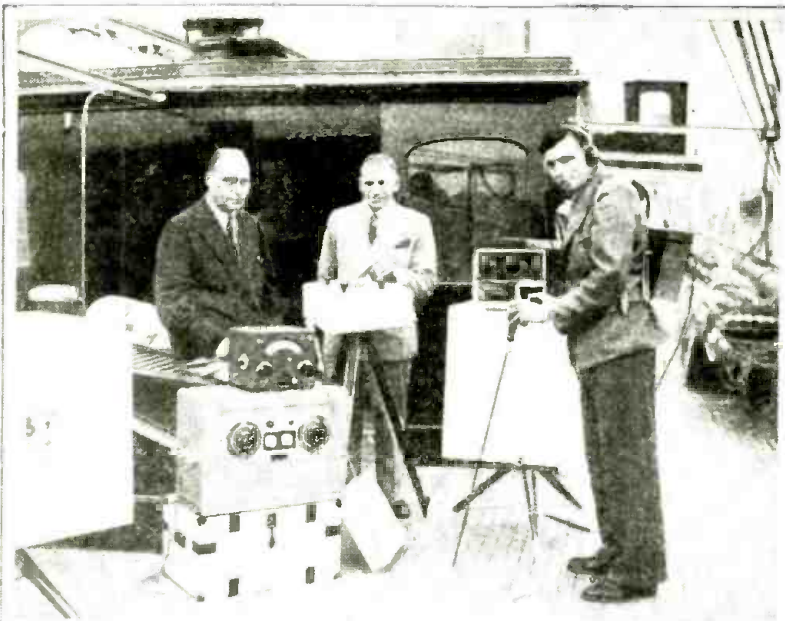

How would you like to find \$30,000,000? That is what an expedition which just left London for Cocos Island expects to find in the form of buried pirate treasure. This expedition is lead by Commander F. A. Worslet, of Arctic fame. At the right of the photo is a portable treasure locator strapped to the back of one of the searchers. The long rod is pushed into the ground.

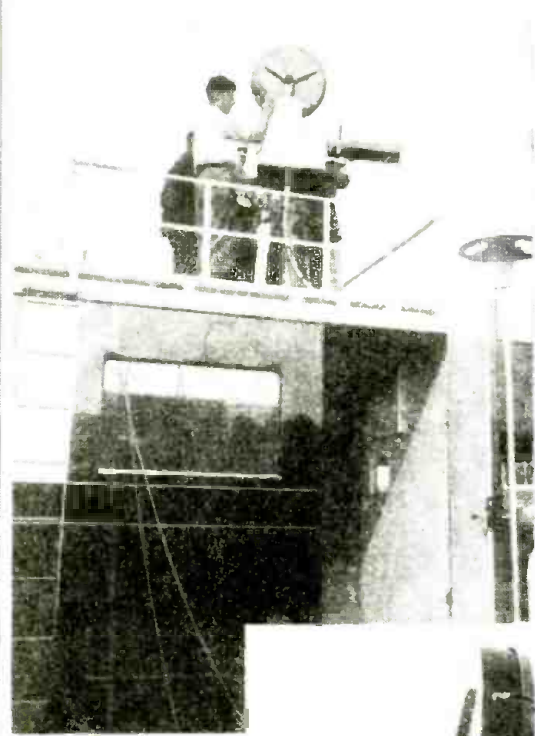
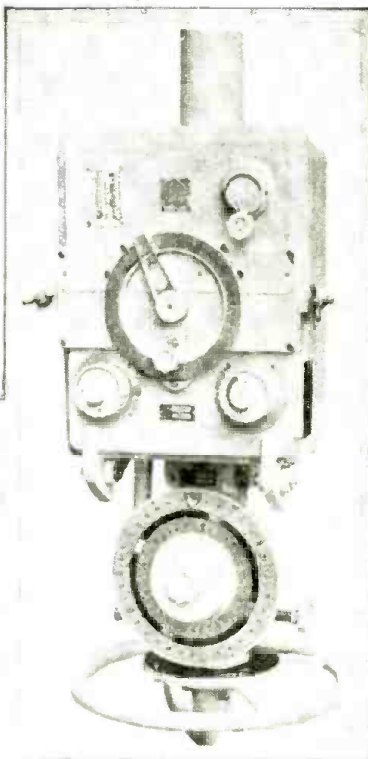

THE three views on the right show details of the radio equipment used on lightships in Europe. Below is a typical ship with its tall masts, supporting the regular transmitter, below which is the visual light. The two photos above show details of direction-finding equipment made by a large German firm and used in these lightship installations. The central view shows a complete installation, while the upper one is the terminal equipment.

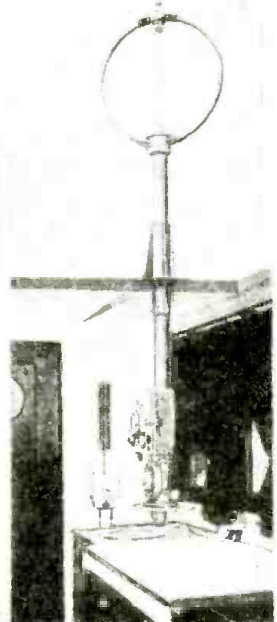

DIRECTION finding for ships at sea has become as essential as the compass and sextant in finding position and guiding a ship through difficult or dangerous channels and harbors. The lightship has played an important part in this work, also, as some locations preclude the use of land equipment for the purpose. The Nantucket lightship, which was tragically sent to the bottom because of the high efficiency of her "directive beam" equipment, is a notable example of such a location. The equipment shown above is the European equivalent of the devices used on this and other lightships.

The photo directly below shows some of the extreme measures used in the design of radio equipment to cover special purposes. Trouble has always been experienced in equipment designed to generate high frequencies because changes in temperature make coils expand and contract and alter the electrical inductance. This booth is equipped with electric heaters and a refrigerator to produce wide temperature variations.

Westinghouse photo.

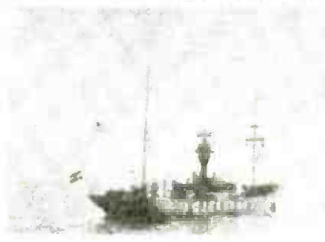

AT THE opening of the Berlin radio show recently, the television movie camera, shown above and at the right, was demonstrated in action. This camera had a huge objective, 25 ins. in diameter which can readily be seen in the closeup view. The picture above shows the camera as it was installed at the radio show, on a high platform overlooking the display booths.

While no technical details are available at present regarding the methods employed in this television system, it is interesting to note that television has developed to a stage where commercial instruments are being manufactured in Germany to send television pictures.

A. N. Mirzaoff photos.

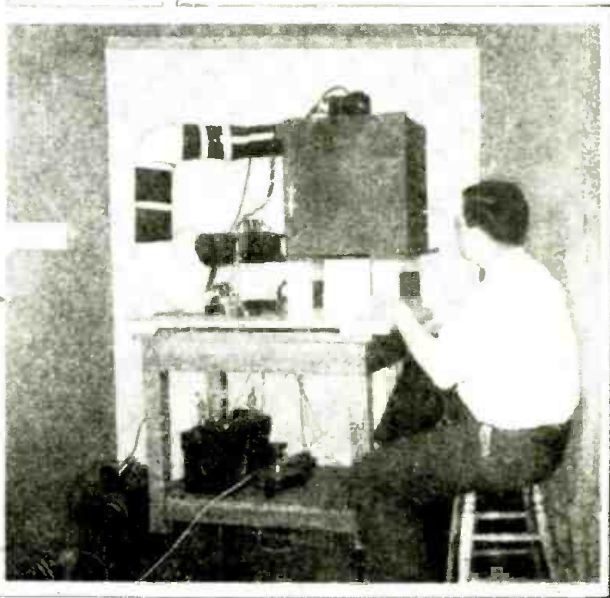
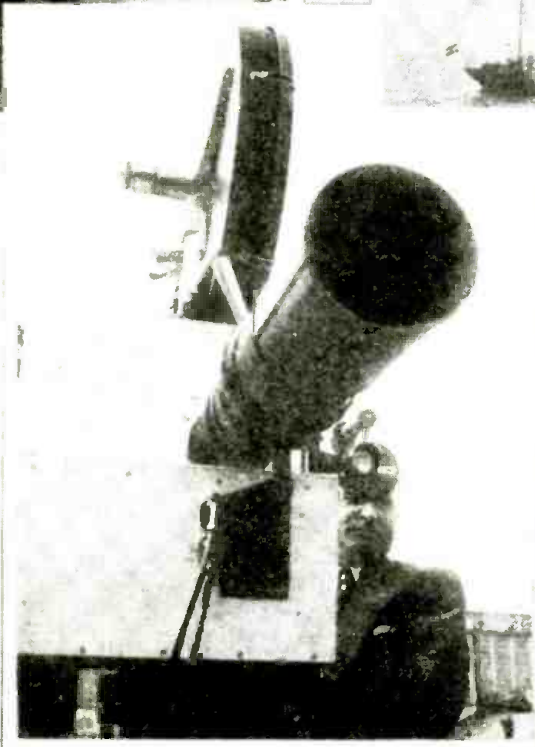

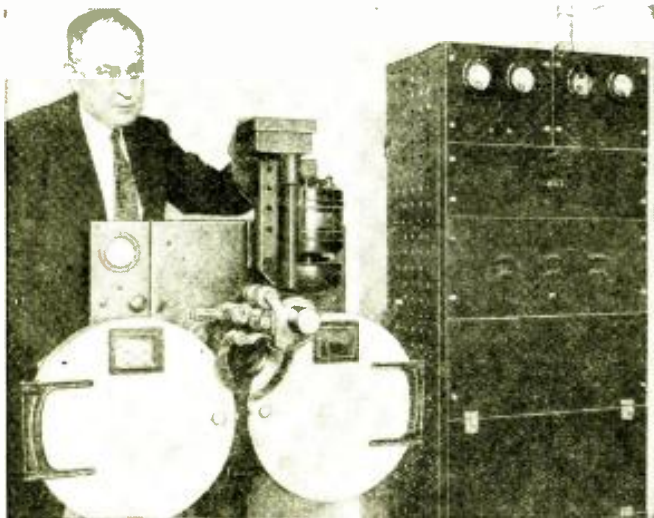

Fig. A. W. H. Peck, and motion picture television transmitter.

LATEST IN

A new idea in television, invented and perfected by William Hoyt Peck, noted engineer, was recently demonstrated in New York City. Both the transmitter and receiver are the products of intensive research work, and incorporate many amazing and original ideas. It will give a "black-on-white" image which, in detail, is comparable with home-movie pictures. The result is a picture 14 inches square when projected on a screen and viewed just as one would look at home movies. The receiver will be commercially produced and for sale within a short time.

DESPITE the pessimism of so many "experts" and so-called "leaders" in the radio industry, television progress goes on unabated. And recent developments in this field seem to indicate that the day when television will be commercially available and in popular use is now closer than ever. That is, providing its successful adaptation is contingent only upon a practical means of receiving and projecting a clear and sizable picture. For this most recent and amazing development, which we are about to discuss, has been made in this direction only. Unfortunately, this country is poorly equipped, at the present time, to satisfactorily permit merchandising practical and successful commercially-made television receiving equipment. While in Europe considerable activity will be found in television broadcasts and reception tests; somehow the larger radio organizations in the U.S. have been rather slow, almost reluctant, to encourage such work or even permit an encouraging word to seep out from their laboratories to an

awaiting world. This in the face of an apparent stagnation in the development field of the radio industry the remedying of which television could do much for.

While, admittedly, the difficulty of obtaining the necessary wide channels required for the broadcasting of television impulses has done much towards retarding its development, nevertheless experimental channels have always been available to sincere and responsible organizations. Somehow the leaders(?) in the radio field failed to take the initiative by securing these channels and sponsoring extemporaneous broadcasts. These earlier efforts would have helped considerably in promoting the growth of television and bringing its development to a successful completion sooner than can now be expected. Their hue and cry that to promulgate satisfactory television broadcasts would necessitate an investment of over \$80,000,000 is by no means comparable with the pioneer spirit of old-time radio men and organizations. The rapid growth of the

radio industry cannot certainly be attributed to any "cautious and conservative investment" policy of those who have been responsible for its growth. While it is said that the success of television would tremendously injure the motion picture industry, and that allied "big interests" are inclined to check television progress so that their investments may be protected, it seems foolish that at least other organizations, who are independent of any such affiliations, cannot take the initiative by installing experimental studio and transmitting equipment. These experimental stations would, at least, facilitate marketing satisfactory commercial receivers, the sale of which should more than counterbalance the expense of installing and maintaining the television studio and transmitter.

A Practical Talkie-Television Receiver

It is unfortunate that at a time when the country is least prepared for it, a practical and successful television receiver has been developed. Its commercial features are numerous, out-

Fig. B. Illustrating the simplicity of the television receiver.

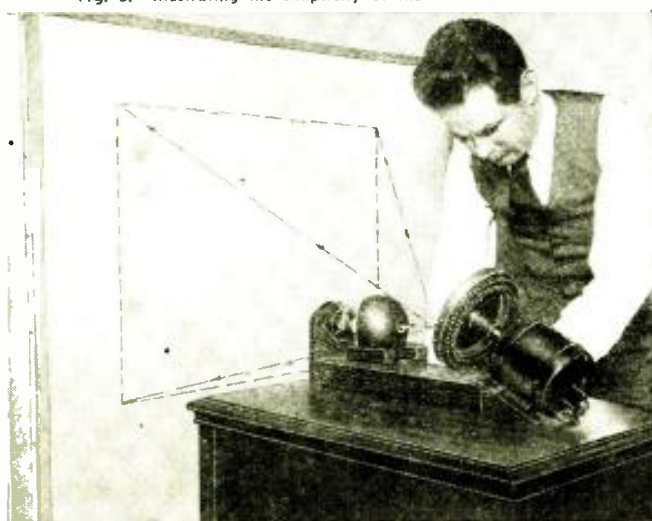
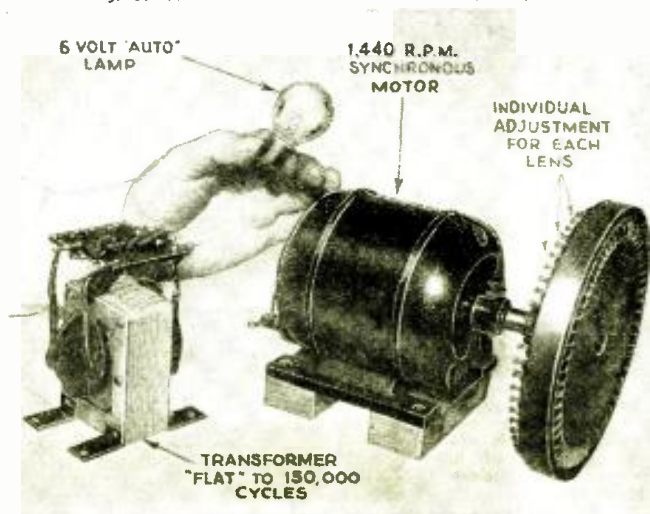

Fig. C. At left is transformer—"flat" to 150,000 cycles.



TELEVISION

Among numerous features of this new and complete invention are many that will astound radio engineers. For example, Mr. Peck employs, in his amplifier, iron-core transformers with a "flat" up to 150,000 cycles—hitherto thought impossible! The Bureau of Standards confirms this characteristic up to 70,000 cycles, which was the limit of their measuring equipment. A 1,440 r.p.m. synchronous motor, another seeming contradiction of electrical laws, is further evidence of this inventor's ingenuity. A small automobile headlight supplies all the light.

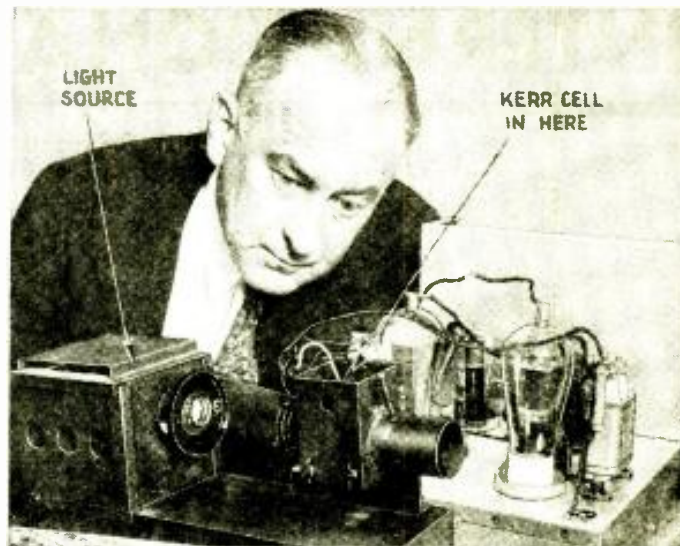

Fig. D. The receiving unit. Note small size of amplifier.

J. T. BERNSLEY

standing of which is that the complete receiving system (housed in a distinctive cabinet) can be made so as to sell for less than \$300.00. The image itself can be projected and enlarged on a screen to a size comparative with 16 mm. home-movie projection. In detail the projected, televised image is practically as clear as home-movie pictures. The most distinctive feature is that the image is of the "black-on-white" type, similar to ordinary movies.

Insofar as the technical features and mechanical construction of the receiving system are concerned it is surprisingly simple and foolproof. At a recent demonstration given by Mr. William Hoyt Peck, the inventor, and his associates, a member of this magazine's editorial staff was given every opportunity to analyze and study the equipment, besides witness a most complete and convincing demonstration. The laboratory set-up utilized for simplicity a direct-wire connection between transmitter and receiver. The former consisted of a 35 mm. movie projector but, instead of the usual high-intensity arc

light a simple 6 V., 21 candle power (automobile headlight type) lamp was employed. This more simple and economical method is made possible by the use of a special mirror-lens scanning disc (Fig. G) which permits more than 80 per cent of the light to be actually used. Compared to the old "pin hole" scanning disc system, which was extremely inefficient, this development is in itself a radical improvement. The motor which drives the scanning disc, (Fig. H), in the receiver is another sensation. It is a 1,440 r.p.m. synchronous motor—a feat of operation heretofore considered impossible according to existing electrical laws and theory. The design of this motor was made necessary by the fact that most television pictures will probably be transmitted from standard 35 mm. "talkies" film. Inasmuch as standard motion pictures are projected at the rate of 24 "frames" or individual pictures per second, or 1,440 per minute, a synchronous motor of 1,440 r.p.m. was an absolute necessity.

There are no gears whatsoever in

Mr. Peck's motion picture transmitter, resulting in a tremendous reduction of
(Continued on page 358)

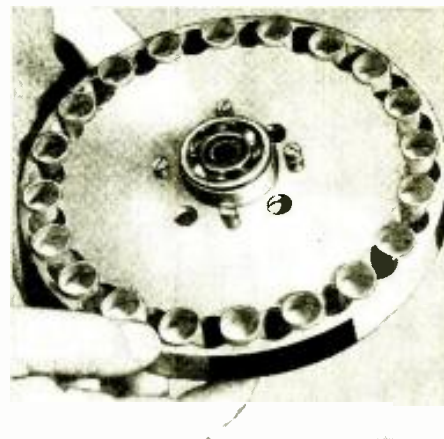

Fig. G, above
Transmitting scanning disc and fixed mirror-lenses. Over 80% of the light is thus saved, resulting in a clearer picture.

Fig. H, below
Receiving "scanner." Note how the angle of each mirror-lens reflects the light, creating the desired "spiral" effect. Lenses below are for larger equipment.

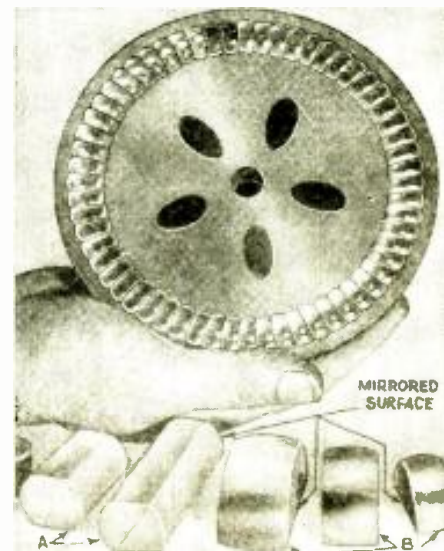

Fig. E. No vibration, proven by balanced coin.

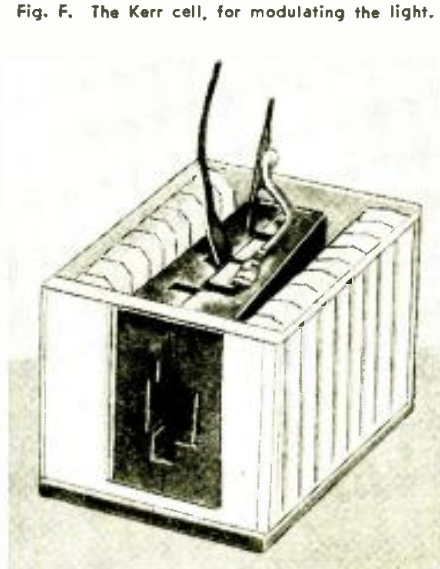
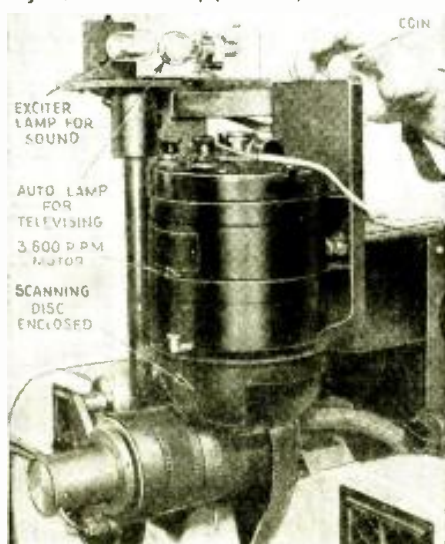

Fig. F. The Kerr cell, for modulating the light.

INTERNATIONAL RADIO REVIEW

NEW TUBES—9 PRONG TWIN PENTODE; CLASS B

IT APPEARS, from a review of recent magazines, that the moratorium on the production of new tubes in America has permitted our over-seas cousins to steal a march on us. There are now available to the British trade the Mazda type QP.240 tube, and the Marconi and Osram type QP21, both of which comprise two battery-type pentodes in one envelope!

The "QP" in the type code indicates that the tubes are designed for operation in "quiescent push-pull" (Q.P.P., or "quip" as it is familiarly called), or, as we over here know it, class B or "push-push."

The type QP240 tube, states the June 29th issue of WIRELESS WORLD (London), has a 9 prong base! This innovation in tube design is illustrated at A in Fig. 1. The filament consumption of this "double-pentode" is 0.4-A.; screen-grid and plate potentials, 150V. The screen-grid connections are brought out to separate pins on the base so that the pentodes can be matched by applying different screen-grid voltages to the two pentode sections of the tube.

The plate-to-plate load impedance is about 20,000 ohms, and the total "quiescent plate current" about 3.8 ma. The power output is about 1.3 W. The coupling transformer feeding the control-grid elements has a *step-up* ratio of 1 to 8.

THE second tube in the "Q.P.P." group, the QP21, is also designed for battery operation. By making internal connection of the screen and suppressor grids only 7 prongs are required on the base.

It was this tube which the publication RADIO CONTACT (Bromley, Kent) selected as the second of two tubes in their "Mystic 'Q'" circuit, reproduced at B in Fig. 1; this set develops the amazing output power of 2 watts!

Following are the constants for this circuit: Resistor R1, 1.meg.; R2, 40,000 ohms, Condenser C1, 500 mmf. adjustable—set for desired selectivity; C2, 200 mmf.; C3, .25-mf.; C4; 500

EACH month there are received at the offices of RADIO-CRAFT hundreds of daily, weekly and monthly magazines originating from all over the world.

SINCE the cost of subscribing to each of these would be prohibitive for most radio men, we have arranged with technical translators to prepare for our readers reviews of all the really important, new developments illustrated and described each month in these publications.

NOTE that the only available information is that which is published; the experimenter must adapt the ideas to whatever equipment he has on hand.

mmf. tuning condensers; C5, 300 mmf. ("differential" type); C6, .005-mf.

A factor in obtaining sufficient selectivity in this regenerative receiver is the inductance unit L, which utilizes cores made of iron-dust (see recent issues of RADIO-CRAFT).

According to the September 8th issue of AMATEUR WIRELESS (London), interest in item C in Fig. 1, a product of the company known as "362", centers in the design of the cathode. This consists of 4 parts; a central tubular insulator around which the heater is wound and through which one end of the heater returns. A second tube insulates this assembly from the cathode shell. This tube is a refractory of high insulating qualities, a factor which eliminates "cathode hum." The cathode shield itself consists of a solid nickel sheath on which is deposited the emissive material. One tube in this series is the ACPX4, with an output of 2½ W.

RADIO TIMEPIECES

AT A IN Fig. A is illustrated a timepiece described, in WIRELESS WORLD (London) of August 17th, as the "Willis World Clock—The Time Anywhere."

In place of the customary revolving

hands the clock is fitted with a dial which makes one complete revolution every 24 hours. If this is set to show local time, fixed points on the surrounding chart indicate the corresponding time at any point on the globe. A separate hand and dial are provided to indicate minutes.

ALSO in WIRELESS WORLD, but in another issue, we find the "Arnold Programme Watch" illustrated at B in Fig. A.

About the size of an ordinary watch, this timekeeper is set by turning the bezel to the time at which it is desired to hear a radio program. Then, you turn the stem, which winds both the clock spring and an alarm spring. Suddenly you are aroused from your reveries by the loud, clear call of the alarm, informing you that "programme time" has arrived.

NEW LOUDSPEAKERS

HERE we go, with short descriptions of a whole "slew" of new loudspeaker designs—some merely novel, and others real improvements, as shown in Fig. B.

Modernistic trends in interior decoration have been captured and portrayed in the design of the "bowl" re-producer shown at A, and reproduced from the August 10th issue of WIRELESS WORLD (London).

ALSO in WIRELESS WORLD, but under date of August 17th, we find the Michell and Brown speaker illustrated at B. This instrument is a combined lamp shade and non-directional baffle giving 360° distribution of the sound.

IN AMATEUR WIRELESS of June 9th we find the "extension" loudspeaker shown at C. The idea is to locate one or more of these speakers at strategic points in the home, etc. An on-off switch is combined with a tone control.

HIGH-FIDELITY reproduction has reared its head in bonnie England, according to ads. in the August 24th issue of WIRELESS WORLD. The triple-speaker arrangement shown at D is utilized in a high-grade combi-

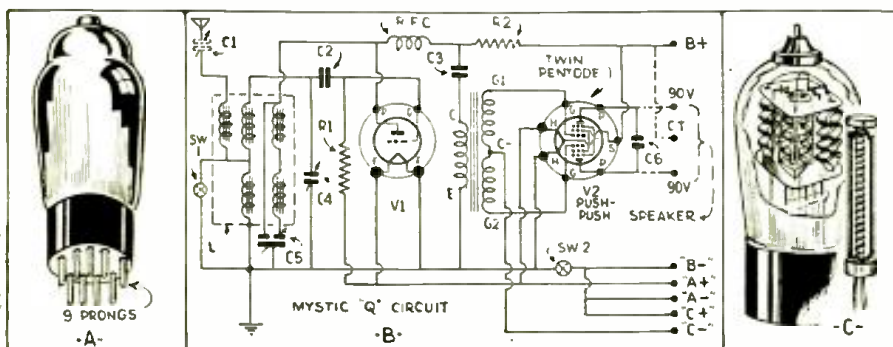
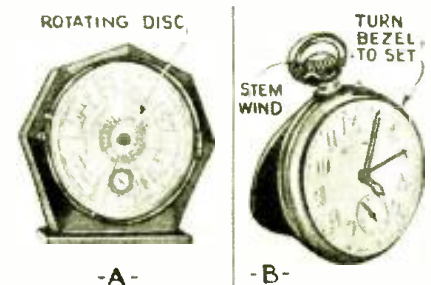

Fig. 1, left. New "twin pentodes."

Fig. A, below. Universal time "tellers."



nation radio and phonograph. High, medium and low frequencies are reproduced by individual speakers.

ONE issue of WIRELESS WORLD reports the unique speaker installation (shown at E) in the cathedral at Regensburg, Germany. This set-up is a novel combination of electric light fixture and P.A. system reproducer, as designed by Telefunken. The sound "sprays" the audience below.

FOLLOWING in somewhat different design the "mushroom" type of speaker shown on page 147 of the September 1934 issue of RADIO-CRAFT, is the radial, 360° diffusing P.A. speaker, for outdoor use, illustrated in the August 24th issue of WIRELESS WORLD, and reproduced at F.

FEATURED by Blue Spot (a company) at Radiolympia, according to the July 28th issue of THE BROADCASTER and WIRELESS RETAILER (London), was the "concentric cone" speaker shown at G. This design results in wide-range reproduction; both energized and permanent-magnet models are available. (The latter is illustrated.)

IMPROVEMENTS in magneto-dynamic reproducer design are reflected in the model shown at H. As described in the August 18th issue of THE BROADCASTER and WIRELESS RETAILER, two brightly-plated cylinders enclose a new magnetic alloy; the ends of these cylinders are clamped between end-plates which form the remainder of the magnetic system. Note the spherical dust cap; a tapped matching transformer is an integral part of the reproducer.

"IF ONE impedance-match doesn't sound right, plug around until you find one that does," is the invitation of the design shown at I—a reproduction from the August 18th issue of THE BROADCASTER and WIRELESS RETAILER. Thirty ratios are provided as a means of obtaining correct matching of this magneto-dynamic ("permanent magnet") reproducer to the numerous tubes of varied characteristics, and

which bring gray hairs to the heads of manufacturers in a country where the salutary effects of standardization are not yet known.

IN ITS June 9th issue, AMATEUR WIRELESS recommended the use of the magneto-dynamic reproducer shown at J, as an extension speaker. In addition to output transformer taps and selector plug, there is provided a jack for plug-in connection of a remote volume control.

RADIO THERAPY HEAD-GEAR

HEALING by means of short-wave radio energy has made slow but steady progress; and medical science is more rapidly realizing the tremendous curative properties latent in ultra-high-frequency waves. A foremost investigator in this field is Dr. E. Schliephake, private lecturer at Jena University, in Berlin. Some of the amazing results he has secured have been chronicled by Dr. Alfred Gradenwitz, writing in an issue of WIRELESS MAGAZINE (London). Using tube-type short-wave generators with output power ratings up to 10 kw. at 2 to 20 meters, the energy is applied to the patient, in most instances, by means of condenser electrodes of the type shown in Fig. C (shown here during treatment of the Maxillar-Cavity). These electrodes are of hollow glass (or hard rubber), in the interior of which is a metal disc which can be shifted to any desired position so that the heating effect in the lower layers of tissue, etc., may be obtained uniformly and gradually.

IMPROVED DEAF-SET

IT HAS been observed that variations in volume occasionally tend to mar speech intelligibility as heard by those whose hearing is poor. To overcome this defect the deaf-set shown in Fig. D, and described in *Wireless World* (London) was developed. A feature is the headphones, one earpiece of which reproduces the middle register, while the other reproduces the upper harmonics and fundamentals.

(Continued on page 381)



Fig. C. One of radio therapy's "tools."



Fig. D. An improvement in deaf-sets.

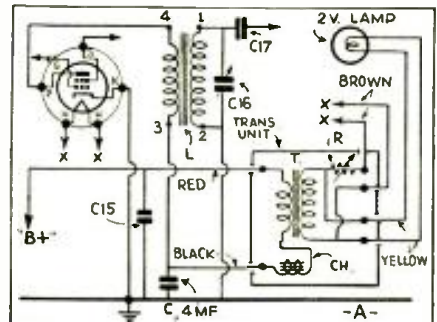
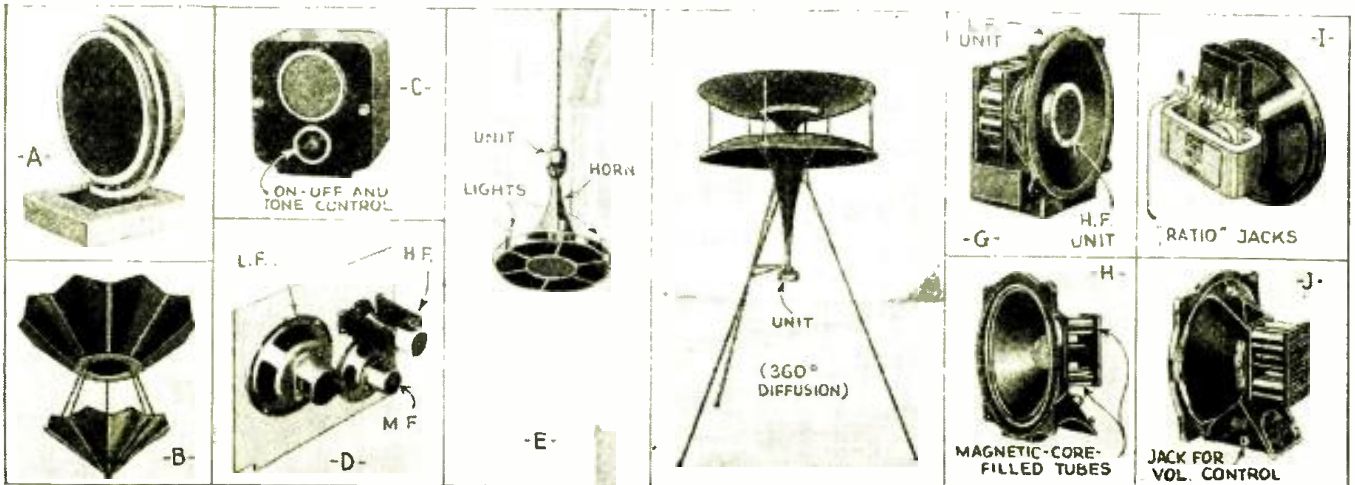

Fig. 2. A "visual tuning" pilot light.

Fig. 8. Assorted speaker developments.



THE MYSTERY SET

Would you like to build a radio novelty that will help you mystify your friends and neighbors? This intriguing device caught the eyes of many visitors at the recent radio exposition in New York City. It will make an interesting and arresting window display for dealers or Service Men.

HUGO GERNSBACK



No apparent light socket connection, yet the set, mounted on a plate glass box, lights and plays! Read how—below.

AT THE recent national Electrical Exposition which was held in New York, September 19th to the 29th, RADIO-CRAFT and associated GERNSBACK PUBLICATIONS had a

large booth where not only magazines but radio sets constructed by RADIO-CRAFT, etc., were exhibited. In order to arouse interest for the 270,000 odd people who attended the show, a number of novel devices were exhibited, and among these was a MYSTERY SET designed by the writer, which created no end of discussion, and which had many radio people and radio engineers guessing for quite a while.

The set, as shown in the illustration, comprises a grooved wooden base (about an inch thick), in which grooves are mounted, edgewise, four pieces of plate glass; these in turn fit into grooves on the underside of a second (three-quarter-inch thick), piece of wood, which constitutes a top or cover. Inside the glass box thus

created there is a sign, "The Mystery Set—How Does It Work?" Placed on top of the cover is the open chassis of a 4 tube, stock model Emerson radio receiver. An aerial about a foot high is also provided, and to make the display a bit more humorous a flower pot containing actual earth is cemented in position on top of the audio transformer. The ground wire is soldered to a nail, which is driven into the "ground." A sign proclaims the fact that the flower pot is the "Ground."

The set was placed so that it could be conveniently handled by individuals in the crowd. You could switch the set "off" and "on," whereupon the pilot light would light and you could tune to your heart's content and also
(Continued on page 375)

A NEW GIANT LOUDSPEAKER

A NEW loudspeaker has been developed which is so powerful that it can amplify the human voice 1,000,000 times, and over flat country in still air be heard at a distance of several miles.

Compared to the results obtained with loudspeakers now in general use, this one is a giant among pygmies. It is 500 times more powerful than the average and in intended primarily for outdoor use, as such sound power is usually too great for an enclosed space. Through the vibration of the diaphragm, words spoken in a conversational tone are hurled into the air

with a total force equal to that of a 50 pound hammer blow.

The speaker has been developed by engineers of Bell Telephone Laboratories for the Western Electric Company. It follows the general principles of those used in talking pictures and public address systems. However, in addition it embodies other unique features aimed to increase its penetration and intelligibility in the presence of other sound.

Speech projected over the speaker is altered in such a way as to penetrate other noise more easily. It can actually cut through a din, which itself bor-

ders on the deafening, and reach the ear intelligibly without adding appreciably to the ear's burden. The speaker accomplishes this by sacrificing naturalness of reproduction and throwing its maximum energy into that part of the voice frequency range which is most essential to intelligibility. Speakers designed for fidelity reproduce sound frequencies ranging from 40 to 10,000 cycles. This new speaker, however, concentrates its power in the band of from 400 to 4,000 cycles.

The amplifier and microphone are also designed to emphasize only
(Continued on page 374)

The new giant 500 watt loudspeaker.



On a coast guard ship at the yacht races.



Making an announcement from the pilot house.



AT THE BERLIN RADIO SHOW

Some new and interesting devices, samples of the developments in Germany during the past few months, were displayed at the recent gigantic radio show at Berlin. A few of these developments are shown here, and explained briefly, for the interest of American radio fans and experimenters.

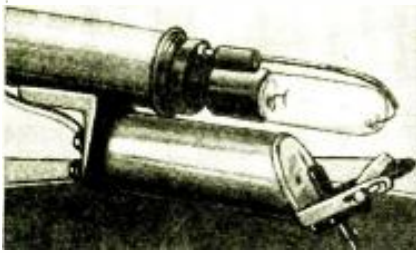

Fig. A. A phono. pickup using a P.E. cell.

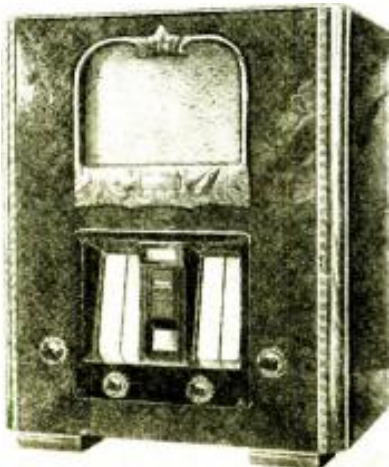

Fig. B. A new set in a modernistic cabinet.



Fig. C, above. A radio set and phonograph.

Fig. D, below. Another unusual cabinet style.



AT THIS time of year, when the radio season is just beginning, it has become customary for radio manufacturers to introduce their new products by banding together and having a "show." Germany, England and America have just completed this annual event, and it is of interest to review some of the novel devices displayed at the Berlin exhibit.

A phonograph pickup of unusual design employing a photo-cell instead of the usual magnetic motor unit was shown for the first time. A glance at the illustration, Fig. A, gives an immediate explanation of the action. An enclosed light is focused through a small pin-hole onto a small mirror which is attached to the needle, in such a way that the vibrations of the needle rock the mirror back and forth. The light is then reflected back from the mirror onto the photo-electric cell with a varying intensity, due to the motion of the mirror.

The advantages of this system over the usual method of having a metal armature in the field of an electromagnet, are in the light weight of the moving parts, thus producing a device with a practically flat frequency characteristic due to the limited inertia of the moving member; the light weight of the entire pickup, thus prolonging the life of records; and last, but not least, the wide variation in current in

the photo-cell by the variation in light intensity produces a device which may be made much more efficient than the magnetic type. The last factor, of course, depends on the relative efficiencies of the various parts that make up the pickup unit.

New Receiver Models

The three next illustrations, Figs. B, C and D show some radical and unusual examples of the new sets to be sold in Germany during the coming months. As noted in this country, the trend in German sets at the presents seems to be toward less tubes. By the skillful application of the multi-element tubes now available, it is possible to obtain very satisfactory results with as few as two tubes; though the average number in the new sets seems to be about four.

The set at B is a "universal current" model, employing three tubes in a superheterodyne circuit. Some of the outstanding features claimed for this set are: a four section tuning system with a practically rectangular resonance curve; iron core tuning coils (as described in recent issues of RADIO-CRAFT, International Radio Review); an effective blocking circuit to prevent second channel superheterodyne whistles; a powerful Q.A.V.C. arrangement; diode rectification and a pentode output tube supplying a full

(Continued on page 358)

Fig. E. Something new in all-wave coils.

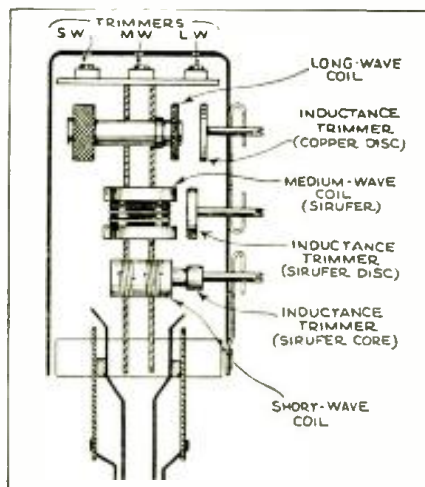
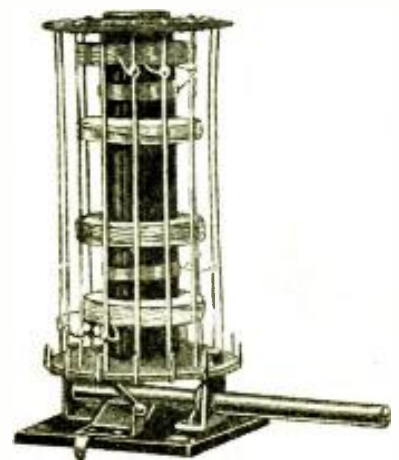

Fig. F. This coil permits short leads.





MAKE THIS UNI-ARM-REST

We consider this receiver to be an ideal portable, since its design will permit operation in any location—independent of the electric power supply that may be available. It may be used in the home as an arm-rest set, as illustrated by the cover picture, or in the car within easy reach of its occupants. The power supply permits this versatility.

FOLD 7 FOLD 3 FOLD 6

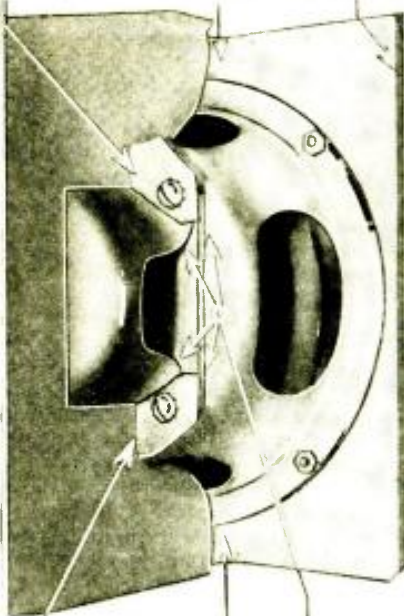

FOLD 8 FOLD 3 SCRATCH

Fig. 8, above. Details of speaker bracket.
Fig. 1, below. Diagram of 7-tube portable.

BEN FRANKLIN probably established the first power distribution system when he flew his kite in a Pennsylvania thunder storm. Since that day the production and distribution of electricity for light and power has proceeded with such swiftness and thoroughness that at the present time we may almost premise the statement that regardless of where we wish to take a portable radio set, some source of electric current will be available, even if it should be no more than the battery in the car which transported us. Accepting, then, the present preference for a universally powered portable to one powered *only* by batteries, it becomes the designer's problem to produce a chassis which will operate on any of the various current supplies we may encounter, and if anything is to be sacrificed to attain this versatility, let the loss occur under conditions least often encountered.

The outfit to be described in this article is a 175 kc. A.V.C. superheterodyne of more or less conventional design, so arranged with regard to choice of tubes and powering provisions that it operates with top efficiency on a 6

volt battery or the usual 110 volt A.C. light circuit, and with only slightly less effectiveness on 32 or 110 volts D.C., or on 220 volts A.C. or D.C. It occupies a space only 8 x 15½ x 9 inches high. On 6 volts D.C., or 110 or 220 volts A.C., it has a power output approximating 2 watts and its sensitivity is around three microvolts absolute (approx. 0.3-microvolt-per-meter). Thus we may say that in the home or automobile we may expect reception on a par with that obtained from the average home receiver of the "dog-house" type or the usual car radio.

Operated on 32 volts D.C. or 220 A.C. we lose nothing in performance, but the voltage dropping resistors employed in these circuits result in a slight power loss. On 110 or 220 D.C. we sacrifice some addition power output, but good performance is still obtained. The net result, then, is a radio which will perform satisfactorily almost anywhere, and which is lighter, more powerful, economical, dependable and rugged than its battery-operated competitor. The present design has been handled in such a manner that it may be easily built by the average set

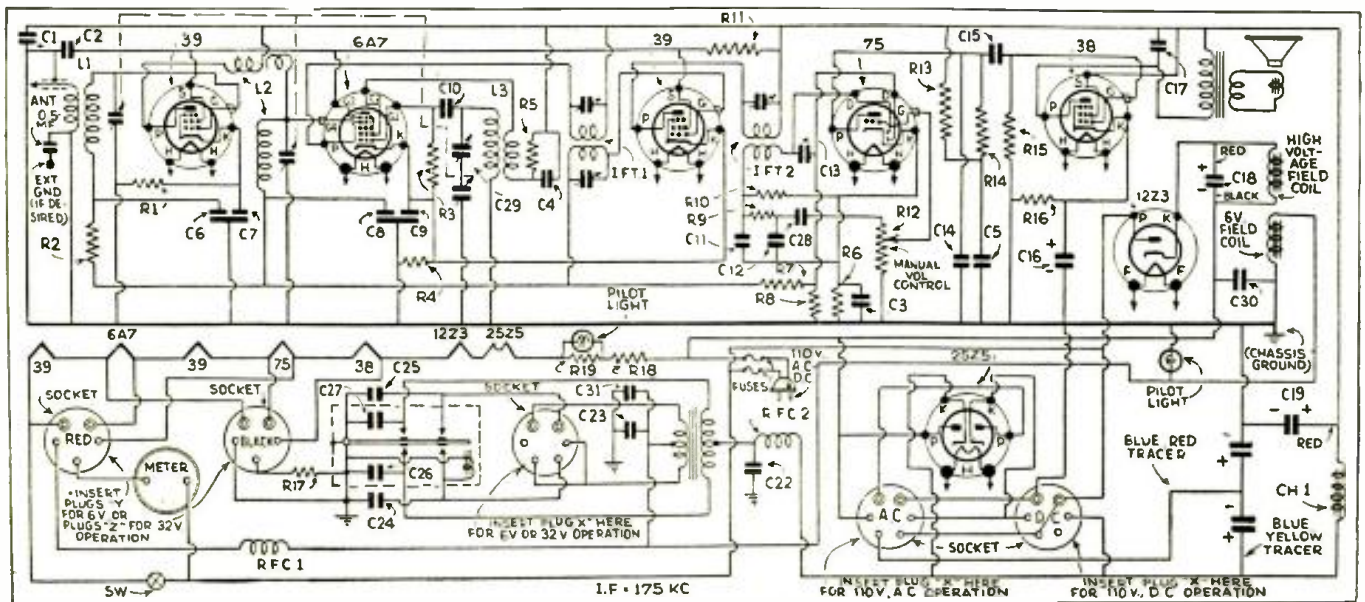

VERSAL CURRENT PORTABLE

A total of 7 tubes are employed in an up-to-the-minute superheterodyne circuit. Ample volume under any average conditions is thus assured. An A.V.C. stage is included to compensate for fading which is particularly noticeable in car or country reception. Full constructional details are included.

RUDOLF STIENMEYER

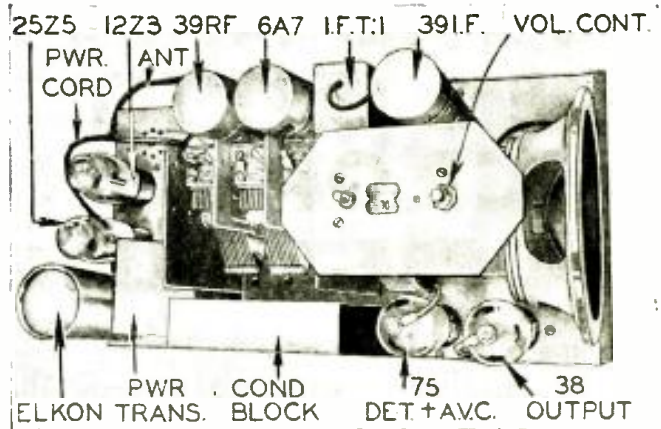

Fig. C. Completed appearance, and layout of tubes and parts.

builder from standard parts.

Construction

The constructional factors are as follows: The chassis pan is made from three pieces of No. 18 galvanized or cadmium-plated steel cut as shown in Fig. 2. At A is the chassis pan proper while B and C are the sides. The metal is first cut to size with ordinary tin shears. A cold chisel and circle shears might be useful in effecting the speaker opening. After it is drilled, the bending is accomplished on an ordinary tinsmith's break except for folds Nos. 7 and 8 which are bent with pliers. Care should be taken to effect the various folds of the large piece in the order in which they are numbered, for should folds 3 and 4 be made first it would be impossible to make the other bends. The three chassis parts are bolted into a unit with 6/32 flat-head iron machine screws, lock washers being placed under each nut.

Before the speaker can be mounted to the chassis, it must be taken apart in order to add the 6 volt field. It is a 6 inch dynamic of the type shown in

Fig. 3 and comes equipped with a 2,500 or 3,000 ohm field coil and an output transformer for a single type 38 tube. (Editor's note: "Midget" speakers with 6 volt fields are commercially available.) The transformer is carefully removed from the frame and the screw which holds the spider is also removed. Then, after making scratchmarks on the speaker frame and air-gap plate to serve in relocating the various parts, the four large assembly bolts are taken out and we have the speaker apart. There is ample space around the original to wind an *additional* field for 6 volt operation, so after slipping a 6 inch length of cambric or rubber tubing over the end of the wire, we wind the entire remaining space full of No. 24 enameled or single cotton covered wire. The winding may be done with the coil removed from the pot, occasionally slipping it into the pot to be certain of not winding it so full that it will not go back. After it has been wound full, a layer of tape is placed over the winding and the speaker re-assembled using the scratch marks to relocate the various parts. Ordinarily the various parts will tend to seek their

original positions; however, should the voice coil air gap not be correct when the assembly is complete, it may be lined up with shims in the usual manner. The output transformer is not replaced on the speaker frame but is mounted on the chassis above the output tube after the socket wiring is complete. The speaker is mounted in the chassis using 6/32 flat-head machine screws around the rim and the two lower speaker assembly bolts on the chassis lugs. The voice coil adjustment will not be disturbed if the other two assembly bolts are left tight.

The sockets are assembled with the clips which carry the heater prongs toward the outside of the chassis pan in each case. They are held in place by means of 6/32 round-head iron machine screws, lock washers and nuts. If sockets are used which grip the tube prongs securely, no difficulty will be experienced with tubes jiggling loose. The filament circuits are wired and tested before proceeding with further assembly.

The gang condenser must be mounted before the R.F. coils, so after drill-

(Continued on page 364)

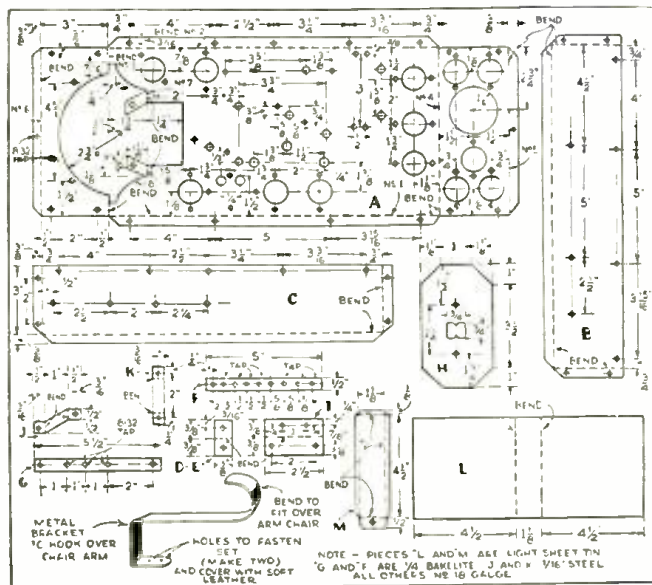

Fig. 2, left. All dimensions for drilling and bending of chassis and brackets.

Fig. D, below. Underside view of chassis and layout. Refer to List of Parts for interpretation of various symbols and values.



HOW TO MAKE A VELOCITY MICROPHONE AND PRE-AMPLIFIER

The use of a velocity mike and pre-amplifier in P.A. installation work, will aid materially in obtaining "high-fidelity" reproduction.

A. BARBIERI*

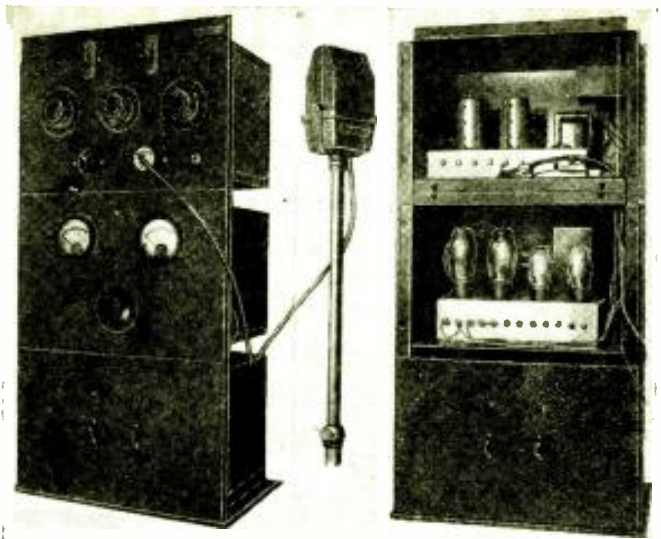

THE velocity microphone, sometimes known as the "ribbon" mike, has been making a name for itself in recent months, wherever high quality P.A. work is emphasized. This type of microphone has also long been used in the larger radio stations, because of its ability to convert sound vibrations into electrical currents with remarkable fidelity. However, it has been neglected in other fields, due to the difficulty in obtaining well made mikes of this type at reasonable prices, and also due to the fact that additional amplification is needed to compensate for the low output level.

Four outstanding advantages are reasons why this type of microphone is better suited for P.A. work, particularly where high fidelity or good reproduction is desired. 1. Wide frequency range with no peaks—therefore, no distortion. 2. Directional pick-up—making it easy to eliminate acoustic feedback. 3. Stability—not affected by temperature, weather conditions, or age. 4. Rugged construction—will operate indefinitely even with rough handling, provided the ribbon is not touched.

Although the ribbon of the velocity microphone is very delicate, it is so elastic that it cannot be damaged by wind or even by dropping the unit. The ribbon itself, however, will not

stand tampering. The velocity microphone will operate for years with the same efficiency if the case is not opened. Atmospheric or temperature conditions have no effect on it whatsoever; for operation where high humidity is encountered, it has no equal. The same is true where acoustical feedback causes trouble. A velocity microphone, in fact, can be used in auditoriums where it is impossible to use any other type of microphone due to such feedback.

The frequency response of the velocity microphone is more perfect than any other type of microphone. It can be made with a flat response from 20 to 14,000 cycles, though, for public address work this wide-frequency range is not necessary—60 to 8,000 cycles being sufficient.

Like all other similar devices, construction care is of utmost importance. This is especially true with the velocity or ribbon type because of its lower

output. Magnets should be of cobalt steel; pole pieces should be machined for maximum gap flux, and transformers laminations of best grade silicon steel. (For music, nickel alloy cores—permalloy types—have been found preferable.)

The ribbon microphone is a velocity device. This means that the ribbon itself must be so light as to follow the vibrations of the sound waves. To obtain such a low mass, the ribbon is made of .0002-in. duraluminum. Also, it is very important that the case be so constructed as to permit full uninterrupted passage of the sound waves. If the ribbon is placed in an enclosed cavity, its frequency range is seriously limited by the cavity. For that reason, cast cases are not used, and a simple construction which will permit free passage of the sound waves can be obtained by using a perforated metal case. A perforation should be chosen in which the hole area is greater than the solid area.

The case construction of a popular velocity microphone is shown in the above photograph. The internal construction is shown in Fig. 1.

The output of this ribbon "mike" is approximately -90 db. In order to bring it up to the level of a carbon microphone (approximately -35 db.) a two stage pre-amplifier must be used, either battery or A.C. operated. (Continued on page 362)

*Acoustic Engineer, Amperite Corp.

Fig. 2
The circuit of the A.C. pre-amplifier.

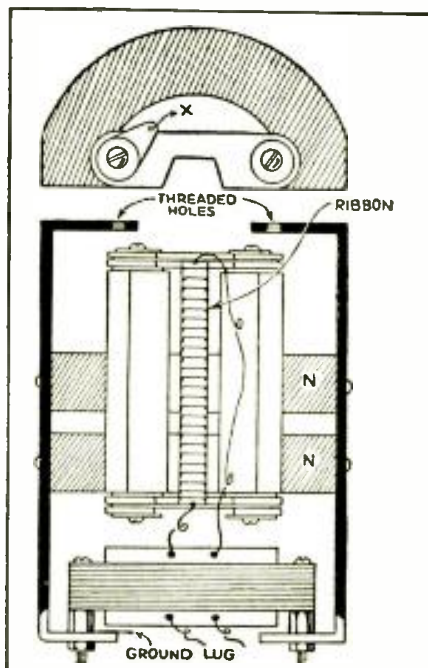
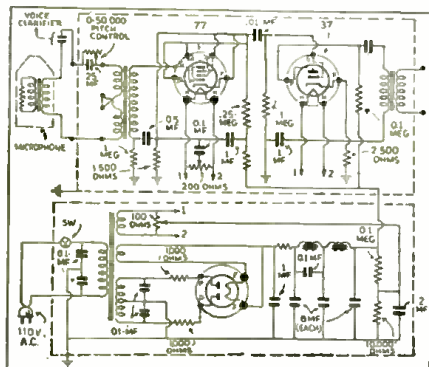
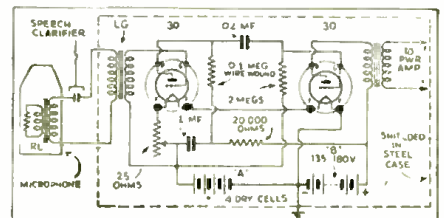
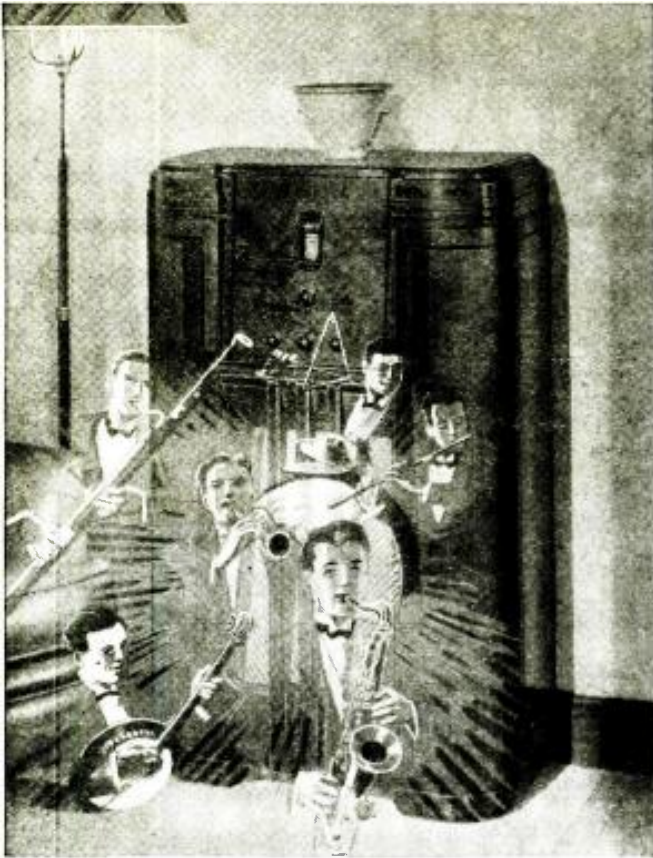

Fig. 1, left. The mechanical make-up of the ribbon microphone with the coupling transformer mounted below.

Fig. 3, below. The circuit for a battery operated pre-amplifier, for a ribbon "mike."





THE PROBLEMS IN HIGH-FIDELITY DESIGN

How many Service Men or constructors know what high fidelity in radio receivers really means? The problems in design involve considerably more than just a wide-range reproducing system and amplifier. It includes complex R.F. circuit design, in addition to problems of acoustics, in connection with the cabinet and the room in which the receiver is installed. In this article the author discusses numerous differences between a conventional receiver and one of "high-fidelity", besides other pertinent factors which all radio men should know.

WILHELM E. SCHRAGE

AN EXPRESSION which is rapidly becoming commonplace to radio set constructors and Service Men is "high fidelity." To the uninitiated the phrase might simply mean, in connection with radio reception or reproduction from a radio receiver, excellent or high quality. Literally, that is correct, but technically, the definition must be more

precise. The fact that a radio receiver may sound pleasing to the ear would not be an indication that its quality is of a high-fidelity nature. To faithfully reproduce all of the various instruments in an orchestra a receiver and loudspeaker combined should have the frequency range of from 50 to at least 7,500 cycles with a total audio volume variation not more than 10 db., total power output not less than 10 W., and total distortion not exceeding 5%. Previously the average "good" set on the market very often had a sound range of only about 80 to 4,500 cycles with a frequency variation generally in excess of 50 decibels, and very few had a power output in excess of 5 W. While the change from the old order, to that which is required for high

fidelity, seems slight, nevertheless the actual technical obstacles are exceedingly difficult.

In so far as the audio amplifier section of the radio receiver is concerned it is a comparatively simple process to so design the successive stages that the frequency range of the amplifier covers the range specified; and with variations not to exceed even 2 db. if so desired. The problem of power output is also easily solved by the use of large power tubes whose power output may exceed the above minimum figure of 10 W. when operated in class A or class A prime, in either of which cases the total distortion would be less than that of 5%. Unfortunately, the difficulty does not center around the

(Continued on page 360)

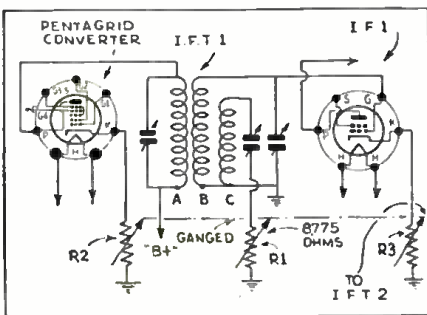

Fig. 1, above
New I.F. transformer, in which R1 sharpens or broadens tuning to aid high-fidelity reception.

Fig. 2, below
Potentiometer coupling between last I.F. stage and the following tube.

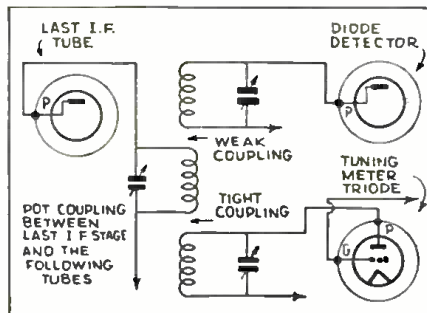
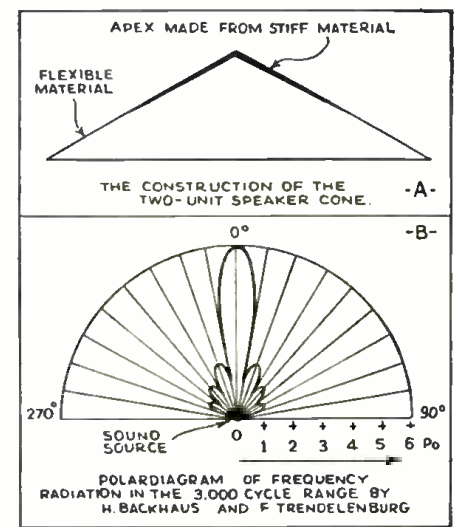
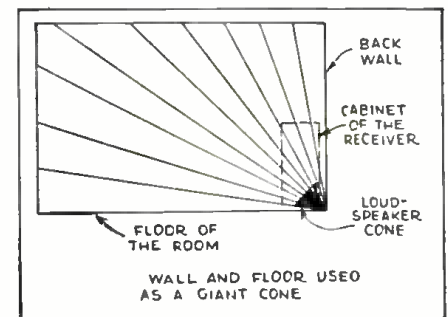

Fig. 4, right
A. Construction of wide-range speaker cone.
B. Note high-frequency radiation from cone is excellent from center, poor from sides.

Fig. 3, below
In high-fidelity receivers, the cabinet and walls should be used to reinforce the speaker sound.



THE LATEST RADIO EQUIPMENT



A BEER BOTTLE SET (579)

WE WONDER who was the brilliant publicity genius that conceived the idea of the "beer bottle" radio set which is now "among us." Service Men who have occasion to practice their wiles on either the 4 tube (magnetic speaker) or 5 tube (dynamic speaker; A.V.C.) superhet. chassis used in this receiver will find that practically all of these sets are in the hands of "wet goods" manufacturers—the instrument is designed exclusively for use in connection with brewery publicity. Tuning of this exceedingly novel set, which is 2 ft. high, is accomplished by turning the crown-type bottle cap which is made of molded bakelite.



NEW AVIATION SET (584)

NEWEST in aviation radio receiver design is a "general purpose" 9 tube superheterodyne that covers, with 15 coils, the wavelength range of 20,000 (150 kc.) to 16.6 (18,000 kc.) meters. This permits reception (with the switch in positions indicated in parentheses) in the following regions: (X) airways weather; (A) entertainment; (B, C and D) aviation communication, police reports, foreign and domestic broadcasts, amateurs, short-wave telephony, etc. Individual switches control A.F. volume, sensitivity, A.V.C., beat-note oscillator, speaker-headphone operation, band selection, and tone control. The undistorted power output is 6 W.

ALL-WAVE SERVICE OSCILLATOR (580)

THIS A.C. operated, electron-coupled service oscillator supplies 400 cycle modulated, continuously variable, R.F. output of 50 to 50,000 microvolts over the range of 100 kc. to 10,000 kc., and harmonics to 50,000 kc. The A.F. modulation is separately available. A 4 stepped ladder attenuator is used in conjunction with a multiplier switch.

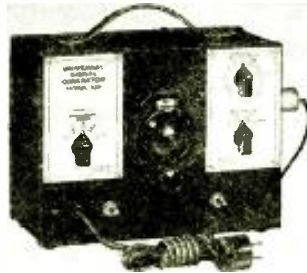

MIDGET ELECTROLYTICS (585)

A KIT of 10 dry electrolytic condensers, two each of 1, 2, 4, 6, and 8 mf., is now available. These condensers are about half the "standard" size for units similarly rated at 150 V. working. Made with lug or lead connections. Internal construction, except in compactness, includes every feature of protective insulation, wrapping, etc., used in larger units.

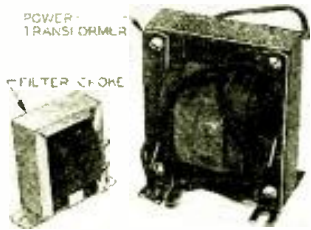

VIBRATOR "B" PARTS (581)

WHETHER the technician is a home set builder or a Service Man, he will be glad to learn that components for vibrator-type "B" units are now available. One make of power transformer is rated at 50 ma., 250 V., full-wave; the filter choke, 15 hy., 30 ma. and 250 ohms. (Other ratings are available.)



D.C. TO A.C. INVERTER (586)

DO YOU have any 110 V. A.C. devices that you would like to operate on 110 V. D.C., 32 V. D.C., or 6 V. D.C.? The new D.C. to A.C. inverter makes this convenient. The instrument operates on the vibrator principle and uses a plug-in unit. Capacities, 50, 100, and 200 W.; and, special, 12 V. and 220 V. D.C. supply.

I TUBE ALL-WAVE KIT (582)

A KIT set is now available for the person who wants to build that "simplest" radio set. Only one tube, a 12A7, is used as a combined regenerative pentode detector and output tube, and current rectifier. Five plug-in coils permit "all-wave" reception, using headphones; (by means of an auxiliary amplifier which may be built if desired, loudspeaker operation may be secured). Controls are provided for antenna compensation, regeneration (volume) adjustment, and off-on operation. A very neat job.



ALL-WAVE LINE-NOISE FILTER (587)

KEEPING line noises out of present all-wave reception is the function of the newest all-wave line noise filter. Any radio set consuming not more than 250 W. may be plugged into the receptacle on the filter. The cable that leads from the filter connects to the power line. The installation is completed by connecting its ground post to any convenient grounding point. Separate filter circuits for broadcast and short-waves are incorporated in this instrument.

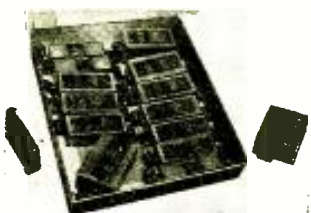

SERVICING KIT ELEC- TROLYTICS (583)

AN IDEAL selection of dry electrolytic condensers of 200 V. D.C. working rating is offered in a kit of 15 units, assorted as follows: 4, 4 mf.; 1, 6 mf.; 4, 8 mf.; 1, 10 mf.; 1, 12 mf.; 2, 16 mf.; 1, 20 mf.; 1, 25 mf.



GASSY-TUBE TESTER (588)

TUBE checkers not equipped with gas current and grid current tests may now have these conveniences. Merely connect this adaptor's grid clip to the tube cap, and the checker grid lead to the stud on the adaptor. Pressing red button; no appreciable change indicates tube O.K.

Name of manufacturer of any device will be sent on receipt of a self-addressed, stamped envelope. Kindly give (number) in description under picture.

MICA CONDENSER KIT (589)

MOLDED bakelite condensers only $\frac{3}{4}$ -in. square are now available in convenient kits of 13 units, plainly branded, as follows (one each): 50 mmf.; 100 mmf.; 150 mmf.; 200 mmf.; 250 mmf.; 400 mmf.; 500 mmf.; 700 mmf.; .001-mf., and .002-mf. These condensers are equipped with tinned copper leads, each $1\frac{1}{4}$ ins. long, permitting the units to be wired directly into circuit, from point to point; the leads are rigidly anchored in the molding.



RADIO-PHONOGRAPH ATTACHMENT (590)

ENTERTAINMENT when you want it, is the keynote of this new, compact (11x8x5 ins. high) phonograph attachment. Its two phonograph pickup leads connect into your radio set. At the flip of a switch you may have either radio or phonograph operation.



NEW VOLUME CONTROL (591)

THE newest control is equipped with an adjustable stop that permits the fixed resistance in the antenna-cathode circuit to be adjusted to any value between 100 and 500 ohms. The switch is of snap-on type.



MOLDED SUPPRESSORS (592)

AUTOMOTIVE radio distributors and spark plug suppressors may be had in "molded bakelite" type. An adapter fits them to "spade" terminals. The resistor is of carbon, its ends heavily electroplated. All commercial resistance values are available.

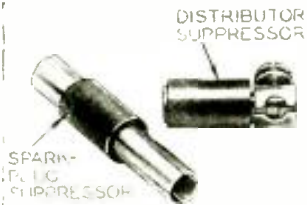

NEW SWITCH AND SHAFT (593)

AN IMPROVED, positive-contact switch has a plate that limits the number of contacts in use, as desired. A new $\frac{1}{4}$ -in. to $\frac{3}{4}$ -in. extension shaft, in aluminum, also is available.

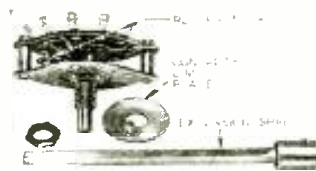

A 17W. P.A. SYSTEM (594)

AN EXCELLENT instrument for electioneering and P.A. work at large gatherings has been developed using a 58, a 56, two 2B6s, and a 5Z3 tube; the power output reading is 17 W.; (net weight, 42 lbs.). A 12-in. dynamic reproducer and a two-button microphone are part of the equipment. This P.A. unit consumes 110 W. at 110 V. A.C. A mixer, fader, and tone control are provided.



SMALL-SPACE PAPER CONDENSERS (595)

FOR the first time, domestic condensers of very small dimensions, in paper-dielectric type, have become available. The 1 mf. unit, illustrated, measures only $2\frac{1}{2} \times 1\frac{3}{8}$ -in. thick; the rating is 600 V. D.C. working (1,200 V. flash test). The same capacity in 1000 V. D.C. working (2,000 V. flash test) measures $4\frac{3}{8} \times 2\frac{1}{4} \times \frac{5}{8}$ -in. thick. Both are made in sizes of .01-mf.; .025-mf.; .05-mf.; 1 mf. and 2 mf.; and besides, in 600 V. D.C. working rating, 4 mf. These condensers are uncase units sealed in varnished wrappers. Use these in place of electrolytics, in warm locations, or where good power factor is desired; use also in compact high-gain amplifiers.



HIGH-FIDELITY AUDIO SYSTEM UNITS (596)

REALIZING the limitations of a single reproducer to obtain high-fidelity response, one manufacturer has developed a series of "full range sound combinations" and associated components. In the figure are shown 2 medium-range dynamic reproducers, one high-frequency dynamic reproducer, a field coil supply unit, and a 2 channel filter unit. (Every conceivable combination is available from the manufacturer; a baffle must be supplied by the consumer.)

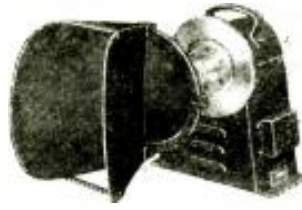

A 2 CHANNEL FILTER; LEVEL CONTROL (598)

WITH good input a 2 channel filter without a variable cut-off but with a high-frequency attenuator is satisfactory. At high volume levels (50 W.) a special-type level control maintains constant impedance into the speakers.



FLEXIBLE 2 CHANNEL FILTER (600)

HIGH-FIDELITY amplifiers using duo-range speakers require a channel filter; a 5 W. limit I.F. speaker input attenuator; and a switch controlling cut-off at 4,800, 6,600, 8,800, 14,600, and 20,000 cycles.



HIGH-GRADE ALL-WAVE RECEIVER (602)

AN ALL-WAVE 10 tube super-heterodyne receiver has been developed which incorporates a number of design features, including A.V.C. The upper or "selector" unit comprises the 12 coil tuning system of the receiver and is similar to the Converter shown as Item No. 576 in the preceding, November issue, but with the addition of a tuning range that embraces the standard broadcast channel. The lower unit contains the I.F. system, the second-detector, the class A amplifying system, and the rectifier unit. This superheterodyne covers the wavelength range of 576.6 meters (520 kc.) to 12 meters (25 megacycles). It utilizes 2 6D6s, 1 6AT, 1 6B7, 1 5Z3, 3 42s, 1 76 and 1 85; power consumption, 160 W.

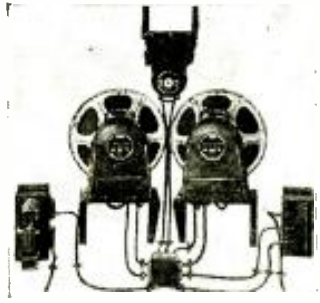

"TWEETER" REFLECTORS (597)

THE high-frequency output of some "tweeter" speakers is transmitted through a wider angle than the "highs" of an "ordinary" speaker, and in order to secure the widest distribution to provide uniform coverage the use of reflectors, now available, is necessary.



FIELD SUPPLY; A.F. TRANSFORMER (599)

IN MODERATE quality high-fidelity amplifiers a field supply output of 25 to 30 will feed 1 "auditorium" and 1 high-frequency speaker. To match the speakers to the amplifier a matching transformer of correct design must be used.



A 7 W.P.A. SYSTEM (601)

FOR commercial window advertising, addressing indoor groups of not over 600 people, or for use at small outdoor gatherings, a new 7 W. amplifier using one 79, two 42s, and an 80. Power consumption at 110 V. A.C. is 7 W. Microphone and phonograph mixers, two-button microphone, and an 8-in. dynamic are furnished.



SHORT-CUTS IN RADIO

FIRST PRIZE \$10.00
 SECOND PRIZE 5.00
 THIRD PRIZE 2.50
 Honorable Mention

EXPERIMENTERS: Three cash prizes will be awarded for the best "short-cuts"—Time- and Money-saving ideas—submitted by readers of **RADIO-CRAFT**; Honorable mention will be given for all other published items concerning radio and its allied fields.
 Send us your "kinks" right away.

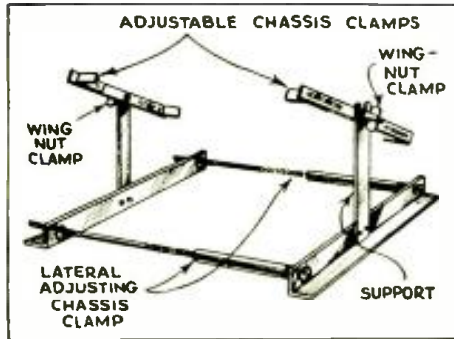

This rack, for rotating and supporting radio chassis, is excellent for Service Men.



SERVICE MAN'S CHASSIS RACK First Prize

THIS adjustable rack was designed for the purpose of saving considerable time and trouble when inspecting or servicing receivers. The chassis, after mounted in the rack, can be rotated to any position, then firmly secured so that the servicing procedure may continue. Thus, by means of this device, any part of the set can be thoroughly inspected without much waste of time and considerable weight lifting.

The device is sufficiently rigid to permit drilling or any other similar work which requires a substantial foundation. Concerning the building of this rack, practically all of the necessary details can be obtained from the above illustration. Steel or iron should be employed in preference to any other metal for its construction. This gives the rack strength to support the heavy set chassis.
FRED VAVRA.



Auxiliary field coils of various resistances help the Service Man make speaker tests.

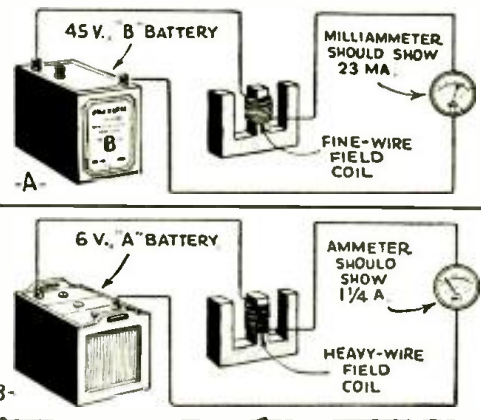

INTERCHANGEABLE DYNAMIC FIELD COILS—Second Prize

THERE are many instances when Service Men find their speaker facilities insufficient for testing a repaired receiver. As is well known by this fraternity, the field resistance of a dynamic speaker of one set may be very much different from that used in the speaker of another make.

The best solution to this problem is to obtain a speaker whose field "pot" is easily removable, and wind up a number of auxiliary field coils which can be inserted and connected within a few minutes. Auto sets, for example, employ a dynamic speaker whose field resistance is between 6 to 8 ohms. For high-resistance coils No. 34 gauge enameled wire is satisfactory. For the aforementioned 8 ohm coil, No. 22 gauge wire is the proper size. Use an ohmmeter for resistance measurement.
GEO. C. WARNER

Here is a beginners' simple code practice set. It operates from an A.C. light socket.

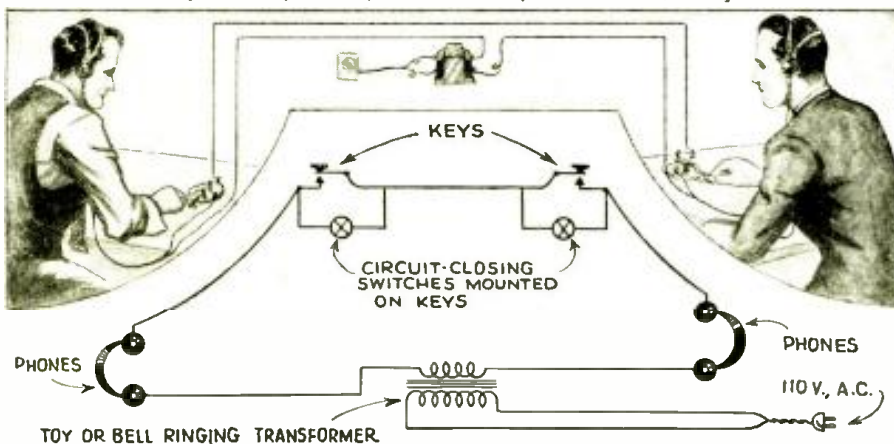

SIMPLE CODE PRACTICE SET—Third Prize
HERE is a practical and simple method of learning the code, or for improving your sending and receiving speed. A step-down transformer, with a 6 volt secondary, is connected in series with two pairs of phones and a buzzer, as well as the necessary two sending telegraph keys. The connections or wiring arrangement is plainly shown in the adjacent illustration.

The telegraph keys are standard "telegraph line" type so that sending or receiving can be accomplished over the same pair of wires. The sender must keep his switch "open," whereas the receiver must keep his switch "closed."

A 120 cycle note is obtained in the earphones, which is not at all unpleasant. The phones must be of the high-impedance type, as other types may burn out. Also, be sure to properly tape all connections to the primary winding of the transformer which leads to the 110 volt A.C. power socket. This precaution will save the constructors from dangerous shocks.—**CASEY IAFRATE**

3 NEW TUBES

Announcements of new tubes show extraordinary variety. Experimenters: use the "acorn" tube, below 5 meters. Set Owners: note the new "long life" improved-80 rectifier. Set Builders and P.A. Men: the 6A6 offers the 53's features at 6.3 volts.

R. D. WASHBURNE



Fig. A. Physical comparison of the new "955" tube with an acorn.

THE TYPE 955 "ACORN" TUBE

FIRST announced as the "shoe-button" tube (RADIO-CRAFT, October 1933, pg. 205), this diminutive tube design has undergone extensive revision until, today, there is little room for comparison, except in size, between the "shoe-button" tube, and the "acorn" tube—just announced by the Amateur Radio Division of RCA Radiotron Co.—and illustrated in Fig. A.

In announcing the newest addition to the list of commercially available tubes, emphasis has been placed by the manufacturers upon the point that the "acorn" has been developed only for amateur and experimental use, and that it is in no way to be considered as a substitute for use in conventional types of receivers. This is an observation the value of which the technical man will readily appreciate, inasmuch as, otherwise, a small army of broadcast set owners, ever on the lookout for something to try out on their set, would besiege the manufacturer with useless inquiries. On the other hand, if the radio man will properly use this tube we may expect some startling developments in new equipment of all kinds, all built around the "acorn." The writer, for instance, in collaboration with several other technicians is working on one item which will depend for its results upon certain of the characteristics inherent only in the "acorn."

The "acorn" tube, which carries the more official designation of "955," is a heater-cathode tube of the triode type, which may be used as an amplifier, detector, or oscillator at frequencies up to 600 megacycles, or about one-half meter in wavelength. The 955 is the only commercially-available triode capable of operating at the ultra-high frequencies and it is therefore indispensable for use in the 2.5 meter, and lower, wavelength bands.

Although not designed especially to be used as a transmitting tube, it may be used as such just as other tubes are used in low-power transmitters by amateurs.

When used for this purpose, sufficient power output is obtainable in correctly designed circuits to cover the line-of-sight transmission distances (20 miles or more, depending upon the relative height of the transmitter and receiver)

generally considered as the distance limit in micro-wave transmission.

Whereas the laboratory-model "shoe-button" tubes previously mentioned were relatively inefficient, the commercial version presents very attractive characteristics. For instance, the amplification factor of the former, in the triode type, was only about 4 per stage; the 955 triode, on the other hand, has an amplification factor of 25—over 600% increase! (On the same basis of comparison, we may expect great things from perfected, commercial types of the experimental *screen-grid* model demonstrated last year—if this model, too, is developed on a production basis; a *direct-heater*, 2V. model in both types, too, would be of tremendous assistance in opening up new fields of research.)

There is no connection base on this tube, nor is there a socket of any type, but the experimenter will find little difficulty in making one to suit his requirements; the elements terminate in short, stiff leads that protrude through, and are held rigidly in the heavy beading of glass that encircles the "waist" of this pygmy in tubes. Circuits designed for operation in the ultra-short—or "micro"—wave region are very simple, and quite easy to operate.

Comparatively little is known about "micro-waves," like light rays—they seem to reach only about as far as the eye can see, and the ambitious experimenter who delves into this virgin field, with the "acorn" tube as an able ally, may be richly rewarded for his initiative.

The cost of a complete sending and receiving set-up is slight—the tube is inexpensive, the coils are easily wound by hand, a variable condenser costing less than a dollar may be used to tune the circuit, and only four dry cells or a 6 V. storage battery are required to light the filament; for "B" supply, a few (small type) 45 V. "B" batteries may be used.

CHARACTERISTICS OF TYPE 955 TUBE

- Heater voltage, 6.3 V.
- Heater current, 0.16-A.
- Max. plate voltage, 180 V.
- Grid voltage, 5 V.

(Continued on page 373)



Fig. B, above. The 6A6 power amplifier.
Fig. C, below. The 80° long-life rectifier.

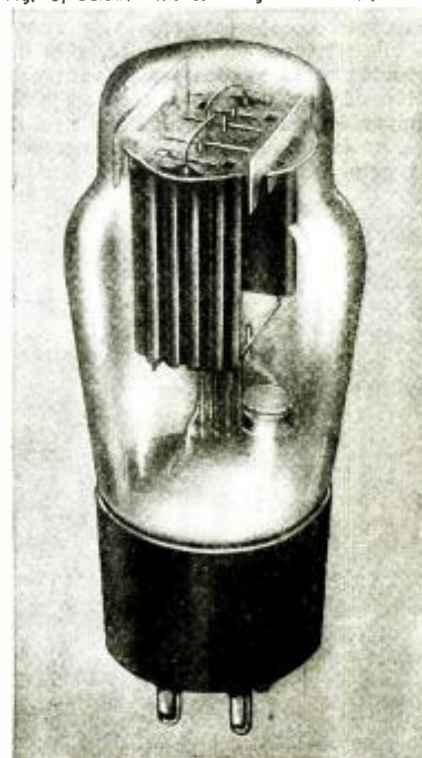

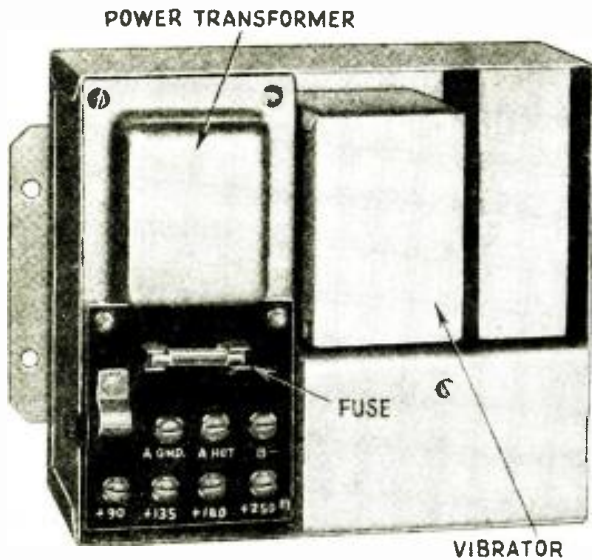

HOW TO BUILD A TUBELESS "B" SUPPLY

The "B" eliminator described here incorporates the latest features in design. No rectifier tube is used. Instead, a mechanical vibrator and inverter replaces it. The power output is more than sufficient for the average rural receiver or auto-radio set. The unit is simple to build, and offers Service Men an excellent means of augmenting their incomes.

C. W. PALMER

THERE are many homes in rural districts where electric power supply is unavailable, that have radio receivers which, of necessity, use "B" batteries. These sets are most of the 2 V. tube type, or of such ancient vintage that they use the old-fashioned 5 V. tubes typified by the 01A and 71A power tubes. However, the receiver's date of birth, whether 4 or 6 years back, is by no means an indication that it has outlived its usefulness. Considering times and conditions, and, by all means, the economical features of these old receivers, we find then ample justification for the retention of such receivers.

Unfortunately, these sets are not always used all year round, due to the constant necessity and expense of replacing "B" batteries. Those who own such sets hesitate to make an expenditure of from 5 to 10 dollars for 3 or 4, 45 V. "B" blocks; particularly when this expense occurs at least twice a year. To those, and other users of battery-type receivers we recommend the construction of this "B" supply unit for completely eliminating "B" batteries. The initial expense is the only expense, even so far as tube replacements are concerned, since no rectifier tube is employed.

To Service Men, particularly those who do auto-radio installation and service work, this unit offers a splendid opportunity to realize some profit on the sale and installation of this device in cars. There are a considerable number of cars that still have installed the battery type of auto-radio set. Generally, the owner of such a set is not only annoyed by the continual expense of replacing

"B" batteries, but also continuously complaining of the poor reception he obtains. This can be attributed to *weak* "B" batteries, inasmuch as good reception is only obtained when the batteries are at their peak and delivering maximum voltage. As they are used, the voltage slowly tapers downward and the set proportionately diminishes in efficiency. Here again we have excellent reasons for the use of a "B" power unit such as will be described. Maximum voltage is delivered constantly, as a result of which maximum efficiency is obtained from the set at all times.

Features

The unit operates from a 6 V. (D.C.) source, and from, in practically all cases, the same storage battery which supplies the filament voltage to the tubes in the receiver. Therefore, in cases where a 2 V. "A" cell is used in conjunction with a 2 V. tube type receiver, a storage battery must be obtained. The storage battery, if of high ampere hour capacity, should last approximately 3 weeks, after which time it can be interchanged with the battery in the car to be recharged. This process can be repeated indefinitely, as a matter of fact it is in popular use now in farms where such units have been installed. Where a 32 V. lighting system is installed, the battery can be recharged, or, if of D.C. nature, the unit may be operated directly from the light socket with the proper series resistor for reducing the voltage to the level required.

(Continued on page 377)

Bottom view of the "B" supply unit; illustrating layout.

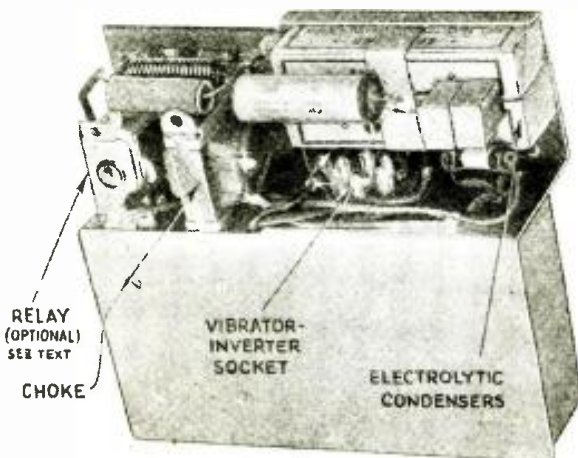
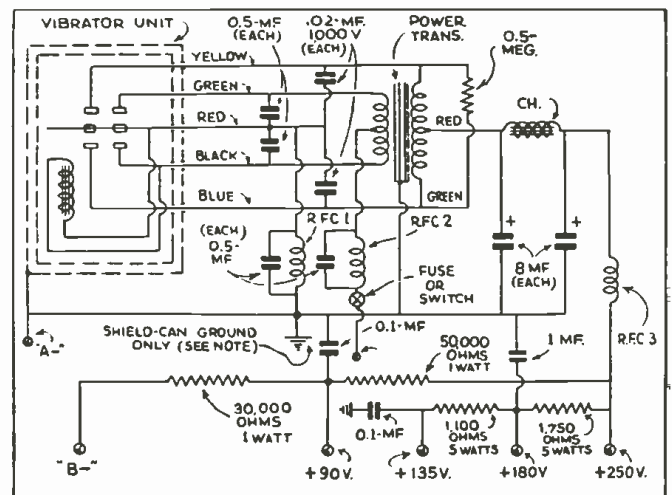

Fig. 1. Diagram. Divider circuit permits intermediate voltages.



READERS' DEPARTMENT

A department in which the reader may exchange thoughts and ideas with other readers.

"CONVERTING BATTERY SETS"— LOCKERD

Editor, RADIO-CRAFT:

The article, in the October, 1934, issue of RADIO-CRAFT, on converting old battery sets has been reviewed with interest.

In the calculation of the correct filament resistance for use with the Air Cell "A" battery, there is one factor that has not been given consideration. While the current drain of the receivers in question is .630-A., this is with 2 V. applied to the filament. Instead, the current drain with a new Air Cell "A" battery should be calculated at maximum tube voltage of 2.2 V. At this voltage, the current drain will be increased by the ratio of 2.2 to 2.0 and therefore will be .693-A. At this current drain the resistance required for a voltage drop of .33-V. will be .476-ohm.

A resistor of .524-ohm as specified in the article will cause a voltage drop with a new Air Cell "A" battery of approximately .35-V. The initial tube voltage will then be 2.18 V. instead of 2.2 V. While this discrepancy does not seem large, the performance of the receiver will no doubt be improved by beginning tube operation at the rated maximum voltage. This lower operating voltage range will also somewhat curtail the service obtainable from the Air Cell battery.

While the discrepancy is not of sufficient magnitude to cause concern, we thought you would appreciate this information in the interest of accuracy and for possible use in any future articles of this nature.

L. S. FOX,
% National Carbon Co., Inc.
30 E. 42nd St.
New York, N. Y.

These comments by Mr. Fox will be greatly appreciated by those who not only wish to operate their sets from a 2 V. Air Cell, but who wish to obtain maximum economy in connection with this type of "A" supply.

BATTERIES FOR TEST EQUIPMENT

Editor, RADIO-CRAFT:

Please allow me to bring your attention to a matter pertaining to batteries for volt-ohmmeters and radio testers of various types.

With the Weston model 564 volt-ohmmeter manufactured in 1930-31 was supplied an Eveready No. 781 battery with two terminals. After trying in

vain to get a new battery in Pittsburgh, Pa., to fit my Weston model 564 volt-ohmmeter I visited the Pittsburgh office of the National Carbon Co., where I learned that the Eveready battery No. 781 was made in two styles slightly different in size: the smaller size with two terminals and the larger size with four terminals. The terminals on the four-terminal battery are too far apart to fit in the slots provided in the Weston model 564 volt-ohmmeter.

The manager of the National Carbon Co.'s Pittsburgh office tried to find a jobber in Pittsburgh who stocked the two-terminal battery but without suc-

cess. (Some mail order houses list the four-terminal battery as the Eveready No. 781, judging from the dimensions given in their catalogs.)

The manager of the Pittsburgh office of the Weston Electrical Inst. Corp. did not know of the two model 781 Eveready batteries, although "many service men have to come to me," he said, "to have batteries sent from the factory at an increased cost for shipping one battery."

The Burgess No. 5360 unit has the terminals about $\frac{1}{4}$ inch too close together to use in the above-mentioned volt-ohmmeter.

There are, no doubt, many men throughout the country who have had much trouble getting batteries to fit their testing apparatus, due to lack of uniformity of batteries used for this purpose.

AUGUST KUIPERS, JR.,
264 Beaver Ave.,
Emmsworth,
Pittsburgh, Pa.

"SUPER-SHORT RADIO WAVES"

Editor, RADIO-CRAFT:

I have read with interest the article which was published in the October, 1934, issue of RADIO-CRAFT, entitled, "Super-Short Radio Waves."

You have not mentioned anywhere that this was a joint paper by Messrs. Linden, Braden, and myself, as appeared on the title of the I.R.E. contribution. Furthermore, several additions and interpretations have been made in the paper you published which were unwarranted by anything I said at the I.R.E. meeting or by the synopsis originally submitted to you. I refer particularly to the first paragraph on page 232 which is entitled, "Modulation Without Sidebands."

No such statement was made. I certainly did not intend to create any impression that we had developed such a modulation system, since I do not consider that this is possible. We did state that frequency modulation could be very much reduced by means of the modulating system which was used. However, the normal sidebands incident to amplitude modulation would still be present. When using centimeter wave transmitters, the frequency swing, due to undesired frequency modulation, is so much greater than any sideband spacing produced by normal amplitude modulation, that the normal 10 kc. spacing used in broadcast transmitters would (Continued on page 374)

"HOW DO THEY DO IT?" should be the title of the view, below, of a price-card exactly as it appeared in the window of a radio dealer in New York City who depends upon catch lines to get transient customers into his store.

No wonder Mr. Set Prospect comes madly dashing back to Mr. Small Town Dealer with fire in his eyes, and goodness knows what violence in his heart, remarking something that sounds about like this: "You're trying to gyp me! I can buy 'in the city' for less than half the price you want, the same identical set you want to sell me!" If the dealer is "wise" to the wiles employed by a small minority of the retail radio stores he may be able to guess something of the true state of affairs—that there was a "catch wording" of the window sign that informed the prospective set purchaser of the "bargain."

Note that, it would appear from the illustration below, there is an "extra special price" on a well-known, high-quality all-wave receiver. Presumably, this extra special price is the figure of \$19.95, immediately following, but such is not the case! If your eyesight is quite good, you may be able to discern the balance of the wording—"allowance on old radio!"

Such dubious business methods are practiced only by short-sighted institutions, for most people shy from doing business with houses that go in for tactics of this type. They may "bite" once, but it is "undertakers'" business—the first sale is the last. And what is worse (or better, as you prefer), they warn their friends against doing business with a firm that tricks its prospects by means of the "misleading statements" racket.

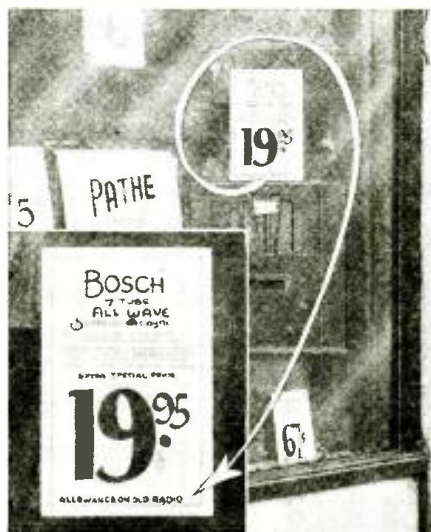

OFFICIAL RADIO SERVICE MEN'S ASSOCIATION, INC.

MEMBER'S FORUM

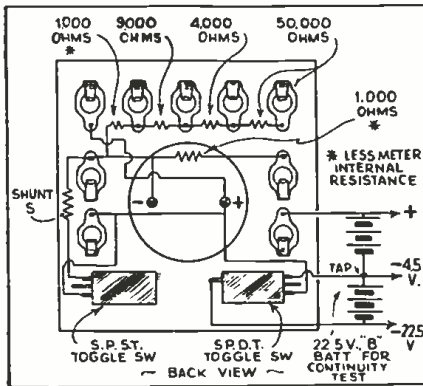

Fig. 1
The circuit of the volt-ohmmeter.

A VOLT-OHMMETER

RADIO-CRAFT, ORSMA Dept.:

A volt-ohmmeter, small enough to be convenient and covering average requirements is a very useful piece of apparatus. For bench work, the usual set analyzer is usually too bulky and is often in the way when you are working; the described apparatus can replace it to advantage where extreme accuracy is not necessary.

The usual multi-range meter is built around an expensive milliammeter and uses expensive multipliers. This one can be built complete for about half the cost of the better meter.

The top row of pin jacks (Fig. 1 and Fig. A) is the voltmeter range. Resistance A is 1,000 ohms less the internal resistance of the meter. B is 9,000 ohms. If this resistor cannot be secured, connect a 3,000 and 6,000 in series or any combination that adds up to 9,000. C is a 40,000 ohm and D is a 50,000 ohm resistor.

Members of the ORSMA will welcome the opportunity of exchanging ideas and experiences in this "meeting place" of the Association.

Every month RADIO-CRAFT will publish the most interesting letters from members for the interest and advancement of the entire Association. Send in your ideas for expanding the ORSMA, now.

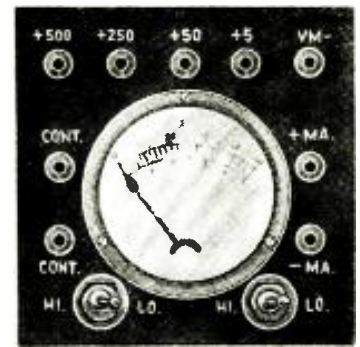

Fig. A
The panel of the simple tester.

The milliammeter range is normally 5 ma. The single pole single throw switch closes a shunt S which doubles the meter range. Any other shunt may be chosen if other ranges are required. This shunt should equal the meter resistance. If the correct resistance is not at hand, connect the meter, a "C" battery of about 4.5 V. and a 2,000 ohm variable resistance in series. Adjust the rheostat until the meter deflection is full scale. Then connect a resistance across the jacks or meter leads. Vary the resistance across the meter until the needle reads half scale. Do not disturb the potentiometer or rheostat in series with the meter during this time. When enough wire is inserted to give exactly half-scale reading, solder it from one jack to the switch. The other switch lead is soldered to the second jack. Then opening the switch gives 5 ma. full-scale reading. Closing it extends the range to 10 ma.

Continuity jacks are connected up

with 4½ and 22½ or any convenient voltage and by means of the single-pole double-throw switch will cover a very wide range, 0-20,000 and 0-100,000 ohms can be read.

Then too, everyone wants an output meter for aligning condensers, etc.

With an adapter easily made from spare parts, this makes a very good output meter. See Fig. 2. An old 5 prong tube base and a socket is all that is necessary. File down the socket until it fits tight in the tube base for a distance of ⅜- to ½-in. Shorten the plate lug on the socket, leaving enough to solder a wire on easily. Solder wires on H, H, K, and G prongs. Drill two holes in the tube base, one ⅜-in. from the bottom, one ⅜-in. from the top. Bare the wires for a distance of about 2 ins. from the ends. Cut off one end, leaving about ¼-in. of wire. Solder this to P prong on socket after pushing it through the upper hole in the

(Continued on page 379)

Fig. 2
Adapter for output meter tests.

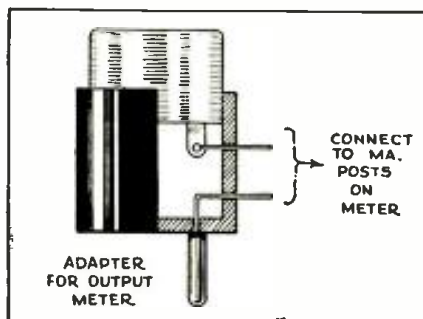

Fig. 3
A wide-range capacity tester.

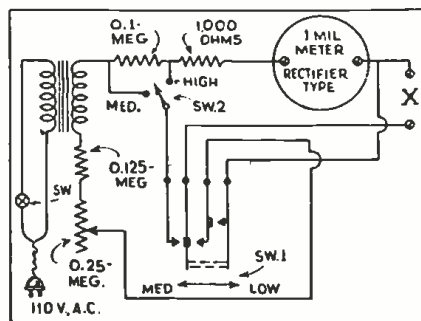
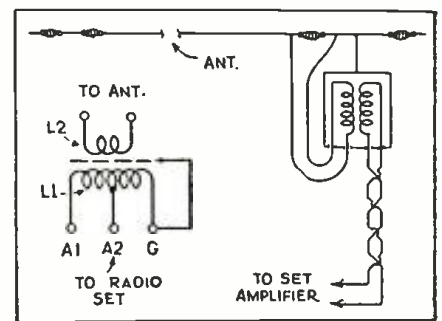

Fig. 4
Improvising "doublet" aerial coupling.



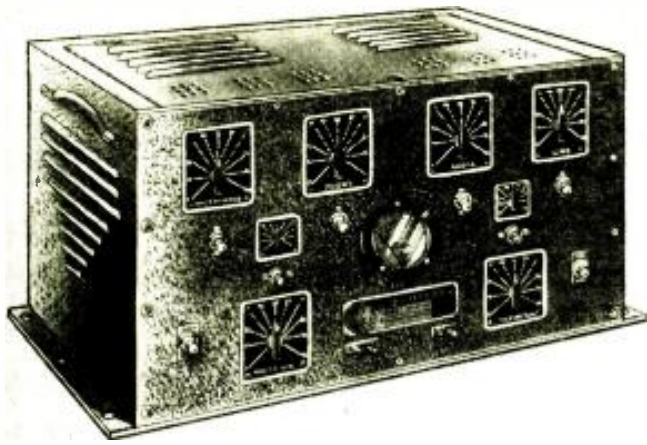

Fig. A. The scales illuminate as the circuits are introduced.

A NEW WIDE-RANGE VARIABLE OUTPUT P. A. AMPLIFIER

P.A. Men will find it to their interest to read about this amplifier which has important innovations. It marks a drastic departure and improvement over conventional design.

CHARLES R. SHAW*

THIS modern public address system combines onto one chassis a high-gain pre-amplifier, a high-fidelity class A voltage amplifier, a high-power class B power amplifier, a 6 volt and 110 volt AC power supply, a 4 position mixer-fader control panel, and an efficient series of circuits evolved around the newest tube—the 6A6. Simplicity of installation and operation of this system is greatly enhanced by incorporating a self-contained control panel, power supply, pre-amplifier, "mike"-current supply and individually lighted translucent control dials—a quick glance at the instrument panel (even in the dark) tells you which device is in or out of the circuit and its degree of attenuation. A snap of a switch permits you to read and adjust the current flowing

through each button of the carbon microphone. The simple insertion of a plug into the amplifier makes it ready for 6 volt operation or 110 volt A.C. use. Another switch offers high or low gain characteristics, while a third switch offers choice of three different audio output levels, 5 watts true class A (with two type 45 tubes), 25 watts class B (with two type 6A6 tubes) or 50 watt class B (with four type 6A6 tubes).

Uses the New 6A6 Tube

The development and perfection of the 6A6 tube marks a new era in the production of universally-powered public address amplifiers inasmuch as it represents the most powerful tube designed with 6.3 volt (.8-amp.) heater and represents a natural outgrowth of the 53 to which it is identical in every

respect, excepting in its heater characteristics (the latter requiring 2.5 volts at 2 amperes). The 6A6, like its older brother, employs an indirectly-heated cathode which functions equally well regardless of whether heater current is obtained from a storage battery or from a 6.3 volt winding on a power transformer. This operating feature eliminates the necessity of replacing tubes or using adapters when changing from 6 volts D.C. operation to 110 volts A.C. operation or vice versa.

Although the 6A6 contains two high-Mu triodes in one glass envelope, which were originally designed to be used as a complete push-push class B output, it is particularly suited for use as a two-stage resistance-coupled amplifier with a gain of 720; as a com-

(Continued on page 369)

Fig. 1. Wiring diagram. Any power output from 5 to 50 watts class A or B can be selected.

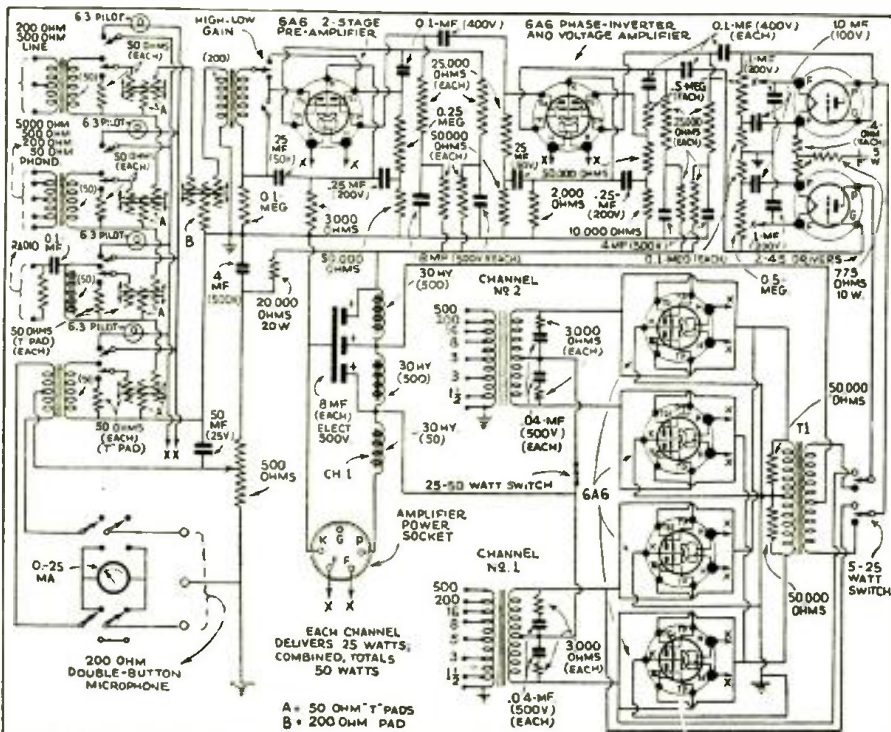
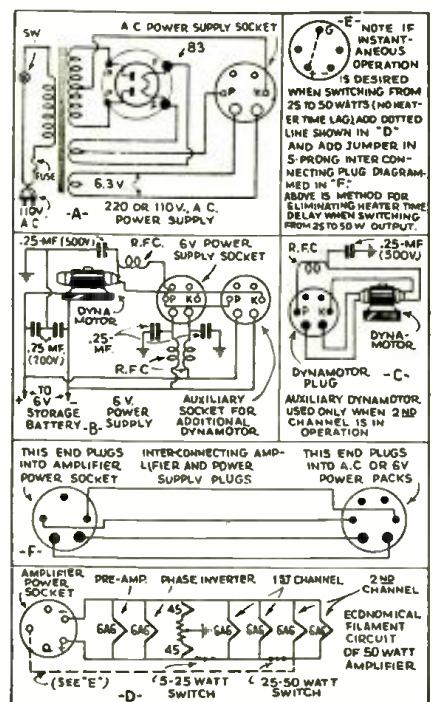

Fig. 2. Auxiliary connections



AN 18-36 WATT P. A. AMPLIFIER

The latest in P.A. amplifier design, and of interest to all public address and sound men! Never before has an amplifier with such tremendous power output, using type 45 tubes, been designed. Four 45s in the final power stage produce an output of 36 watts, more than enough for the average large installation. Other versatile features are described.

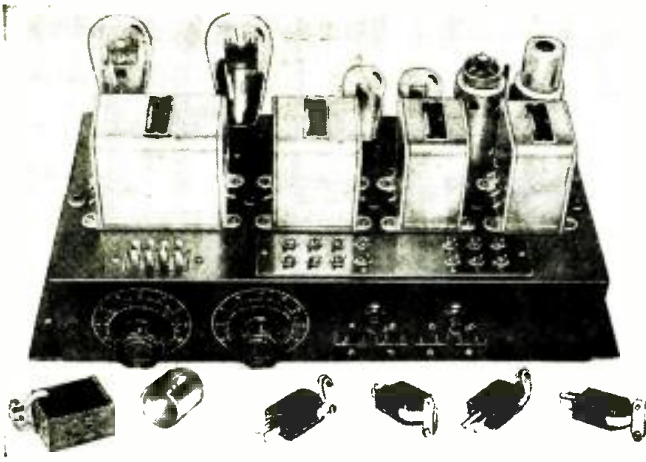

Fig. A. Appearance and parts layout of this novel amplifier.

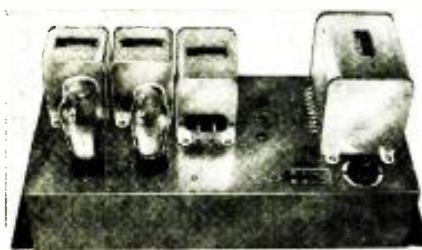

Fig. B, above.
The power supply unit, and layout.

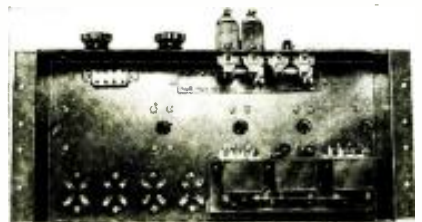

Fig. C, above.
Material employed in under side of amplifier.

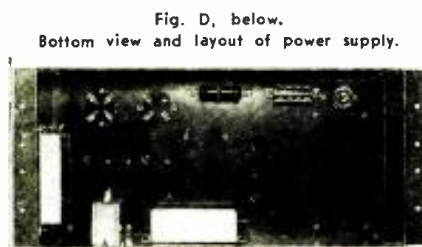

Fig. D, below.
Bottom view and layout of power supply.

EXPERIENCE in the public address field has shown that an amplifying system capable of delivering 30 to 40 W. of audio power will meet the great majority of public address applications. In 50% of these cases an amplifier capable of an output of 15 to 20 W. will prove satisfactory. An audience of 5,000 to 7,000 can be covered by a 20 W. amplifier working into a battery of high-efficiency dynamic speakers. Also, it is well to remember that the full capabilities of an amplifier can only be realized by the selection of an efficient reproducer. Five watts of audio power fed into an efficient reproducer is equivalent to 20 W. of audio power using an ordinary reproducer.

Although power output is probably the most important consideration in this type of work, fidelity of reproduction appears as a very close second. A frequency response of plus or minus 2 db. from 100 to 8,000 cycles should be considered adequate of the amplifier. A frequency response better than this probably will never be realized in the conventional reproducing system. Assuming the reproducers to be unusually good, the auditorium must possess extraordinary acoustic properties to permit a frequency response appreciably better than that set forth above.

Coupled with the power output and frequency response are the very important requirements of economy and versatility. The amplifier should be semi-

portable and capable of use in the sound truck, or of operation directly from the A.C. lines for use in theatres, churches, dance halls, restaurants, etc. To meet sound truck requirements, the amplifier should be economical in operation and should consume no more than 200 to 250 W. power. To meet the portability requirements, the size of the amplifier is limited to the conventional carrying case of 20 x 20 x 10 ins. To meet the requirements of operation in such rigid applications as theatres, churches, etc., the amplifier should be capable of rack and panel installation. In addition to this mechanical versatility, the system should be as versatile electrically as is consistent with the size and weight specifications set forth above. The voltage amplifier should be capable of providing the maximum amplification possible consistent with stability, tube noise, and A.C. hum. The voltage gain thus arrived at will require a minimum of pre-amplification. Standard lines of 200 to 500 ohms should be provided at the input and output of the amplifier. To reduce the bulk as far as possible, some system of mixing various inputs must be made available and integral with the main unit.

The Amplifier

Audio amplifiers may be grouped in three general classifications, the class A amplifier, the class B amplifier, and

(Continued on page 379)

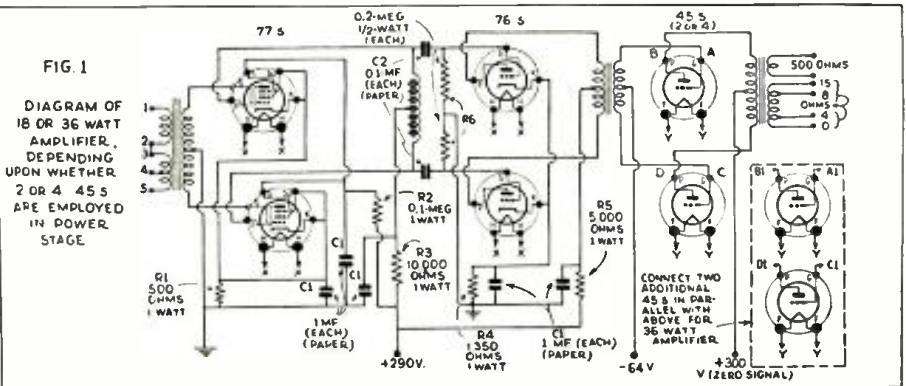
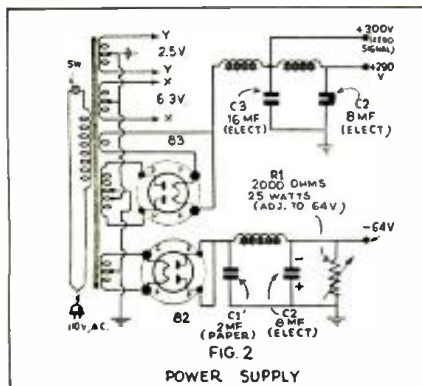

BUILD THIS 5 TUBE MIDGET SUPERHET. SET

While most constructors avoid building midget superhet receivers, because of crowded wiring and layout, this unit should not impress even a layman as being of such design. It employs only 5 tubes, and operates from 110 volts A.C. or D.C.

HUBERT L. SHORTT*

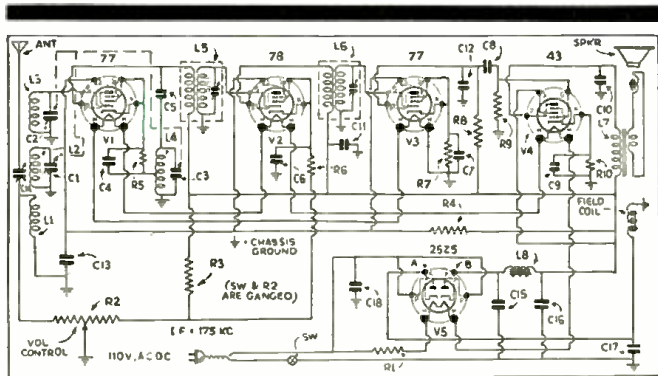

Diagram of this small 5 tube superhet. receiver. Includes a dynamic speaker mounted on chassis. Operates on either 110 volts A.C. or D.C. and, well, too.

*Chief Engineer, Wholesale Radio Service Co., Inc.

ONLY a few short years ago a superheterodyne-type broadcast receiver was an imposing piece of apparatus, with a chassis rarely less than a yard long and containing enough parts to stock a small-town radio shop. The radio fan who had enough money to build one usually spent two weeks on the assembly and wiring operations and another two weeks trying to get the animal to work!

How different things are today! Tubes, circuits and power systems have been simplified and improved to such an extent that a highly efficient superhet, complete with power pack and even a dynamic speaker, can be built into a cabinet measuring less than a foot long and half a foot deep and high. The variable condensers and tuning coils of the average 1931 super required as much space as that alone.

An excellent example of modern superheterodyne tech-
(Continued on page 375)

A MODERN 10 TUBE ALL-WAVE RECEIVER

The features of this receiver are numerous, and of interest to all short-wave listeners and "hams." It incorporates a beat oscillator which permits amateur C.W. reception. Shielded "drawer" type of plug-in wave-length range.

S. MILLER*

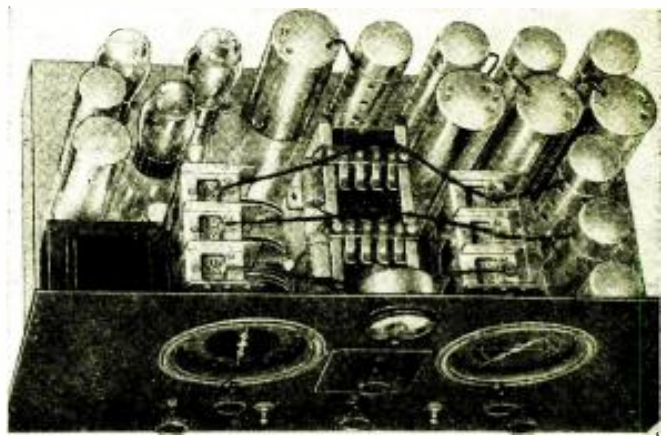

THIS receiver is complete in every detail and can be efficiently used by either the short-wave fan, the

*Chief Eng'r., Postal Radio Corp.

amateur, or the commercial operator without any change whatsoever.

Every worth-while short-wave feature is incorporated in this set, such as

continuous band spread, T.R.F. pre-selector stage, drawer coils, A.V.C., variable audio and radio frequency volume control, electron-coupled oscillator, audio beat oscillator, sensitivity meter, plate supply switch, phone jack, tone control, etc. The entire receiver, including the power supply, is mounted on one sturdy, chromium-plated steel chassis and housed in a beautiful, crystal-finished metal cabinet or for installation in any type console.

Construction

The main tuning is accomplished with a 4½ in. special vernier illuminated aeroplane dial accurately calibrated in meters, kilocycles and megacycles. The operator can at all times,
(Continued on page 374)

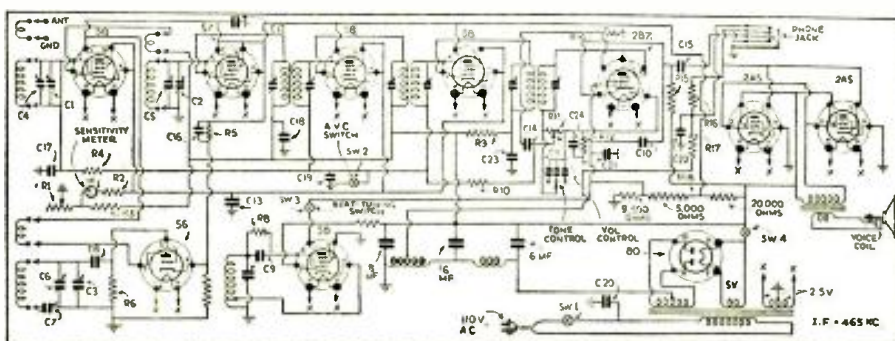



Fig. A. Midget tester helps make the Service Man's task easier.

A SERVICE MAN'S P E E - W E E ANALYZER

The instrument described is a combination set analyzer and point-to-point tester. A single meter permits A.C.-D.C. measurements, volts and ohms tests, all on a 5" X 6 1/2" X 2" panel.

E. J. SAMPSON

MANY attempts have been made, and are still being made, to reduce the extreme bulk that Service Men are forced to carry around with them when making service calls. While most of them perform the actual repair work in the shop nevertheless it is essential that some sort of test equipment, for analysis of the trouble, be taken along to the call. Then, of course, there are numerous tools to be carried for removing the chassis or speaker (or both), or for soldering purposes, replacement of defective parts, etc., etc. Bulky analyzers, while highly desirable from an angle of efficient testing, since they contain all requisite meters for all testing and adjustments, nevertheless present the greatest burden. For that reason RADIO-CRAFT magazine has published numerous types of ultramidget analyzers, so that the Service Man's load might be considerably lightened.

And now we present what we believe to be the smallest practical and complete analyzer that has ever been built. Its functions and capabilities are multitudinous. As a matter of fact, it will do almost everything that the most expensive and elaborate set tester will do. It is a combination set tester and point-to-point multi-volt-ohmmeter. It will measure both A.C. and D.C., employs an analyzer plug and cable (which can be unplugged from the side — for use in a bench test setup) which will permit testing tubes within the receiver; also socket voltage and current analyses. All point-to-point measurements are possible with this unit. The actual dimensions of this instrument (panel only) are 5x6 1/2 x 2 ins. deep.

The ranges of the unit, made possible by the use of a Weston multimeter, are as follows:

- 0-5 V., A.C. or D.C.
- 0-10 V., A.C. or D.C.

- 0-50 V., A.C. or D.C.
 - 0-100 V., A.C. or D.C.
 - 0-500 V., A.C. or D.C.
 - 0-1,000 V., A.C. or D.C.
 - 0-5 ma., D.C.
 - 0-50 ma., D.C.
 - 0-500 ma., D.C.
 - 0-100,000 ohms, range
 - 0-1,000 ohms, range
- (with battery adjustment for both ranges.)

Construction Data

Despite the unusually small dimensions of the instrument, congestion of parts is not true in this case. The primary reason for this is in the selection of proper material for use in constructing the unit. The jacks are of miniature dimensions, and yet with sufficient insulation to eliminate the possibility of breakdown on potentials even as high as 1,000 V. The use of a single

meter of course minimizes the need for considerable space. Two simple toggle switches permit quick and simple changeovers from A.C. to D.C., or ohms or current measurements. Extremely small single-open-circuit jacks facilitate external measurements without creating internal interference in the analyzer circuit. The plugs employed to plug into these jacks are specially designed for the purpose. It should be emphasized at this point that only standard manufactured items that are readily available to any constructor have been used, and are referred to. The multiplier values and shunt resistors are all indicated in the schematic diagram shown in Fig. 1, and must be obtained in the values specified, if accuracy is desired. They are calculated for the Weston multimeter, model 301, and are only suited for this meter. Adaptation of any other type of meter will necessitate recalculation of all necessary resistors.

Fig. 1. Diagram of instrument. The numbered terminals correspond to socket terminals.

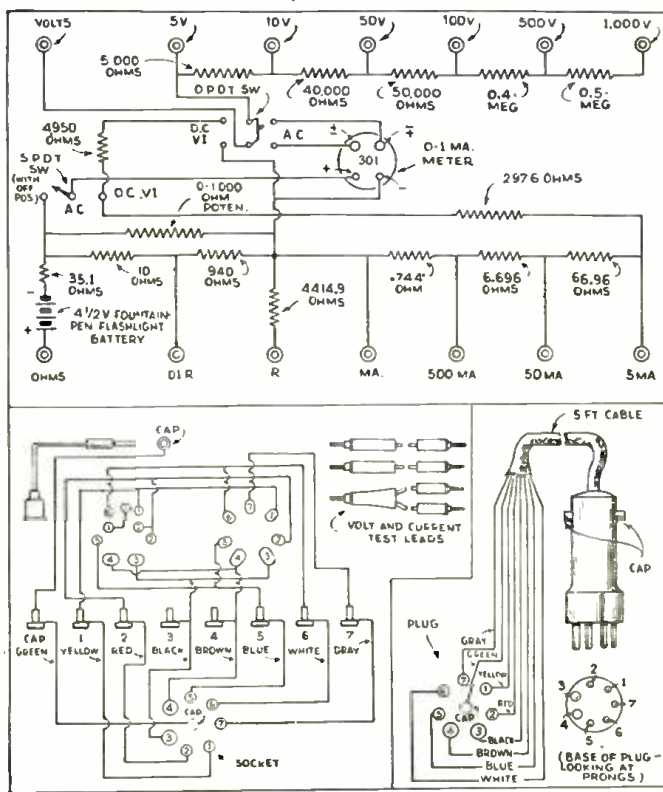

Complete Tests Possible

As explained previously, not only can this instrument be used for point-to-point tests and as an analyzer for reading socket voltages from the receiver sockets directly, but all external measurements as well with the analyzer plugged into the set socket can be made. The 500 ma. range will permit checking the emission of extremely large power tubes, thus making it an ideal instrument for the sound or P.A. technician as well as for the Service Man. Also, the 1,000 V. range of the voltmeter permits testing of power supply devices that deliver high voltages within this range. Inasmuch as no selector switch is incorporated within this unit, all measurements are made by the simple process of connecting two flexible test leads with terminals to the requisite "range" posts on the instrument. The adapter harness connects to

(Continued on page 363)

THE LISTENING POST FOR ALL-WAVE DX-ERS

The listener-in will find, in this department, much valuable data of great aid in obtaining all-wave foreign reception. All suggestions are of a practical nature.

C. A. MORRISON



What to Listen for During November-December

THE season thus far has been characterized by an unusual number of South American stations becoming evident on the broadcast band. Static, the bug-a-boo of every DX-er, and which bothered us all last winter seems to be much less prevalent this season and an excellent DX-ing season is predicted. Australian and New Zealand stations are again with us as was predicted in the last issue of RADIO-CRAFT, and should be easily heard with a little patience and adherence to the rules laid down in the November number. Japanese signals are being reported up and down the Pacific coast. It is a little early, however, for these signals to be heard in the Central or Eastern states. European stations are making an early appearance on the east coast, and by the end of November will be coming in with fair consistency over the Eastern portion of North America.

On the short-waves the 49 meter band is again becoming very active as the summer static wanes. This band fairly bristles with stations, which are in fact a good deal too close together, but provide both top notch sport, and an added incentive to the skill and patience of the DX-er in pulling them out from between their neighboring stations on adjacent channels. One of the surest signs of approaching winter is the early fading out of the 20 meter ham band, and the 25 meter broadcast band. During the summer months it is not at all unusual to hear hams until midnight. Now with the coming of darkness the stations have disappeared until the next day.

The Best South American Stations To Try For

Reception of South American stations is best from darkness to about 8 P.M., E.S.T. Once in a while these stations may be heard on a late schedule or broadcasting a special DX transmission in the early morning hours. Watch the DX calendar in RADIO-CRAFT for all special broadcasts of this nature. In the early evening the South American's naturally occupy the same channels as the U.S.A. stations and may be received only with patience and persistence, and when the local station on the channel is not coming through with as great a signal strength as usual, or is fading. The presence of these foreign signals may be detected by a heterodyne whistle on the local

station. Often during a momentary lull in the local program, or during a speaking period the Spanish stations may be plainly identified in the background. In the eastern portion of North America, often times the South American stations come in louder than the local stations, for a few minutes at a time. The following are the best heard of these stations.

Call	Freq.	Watts	Name	Location	Dial
LR5	830	27,000	Radio Excelsior	Buenos Aires
LR2	910	8,500	Radio Prieto	Buenos Aires
LR3	950	12,000	Radio Nacional	Buenos Aires
LR4	990	12,000	Radio Splendid	Buenos Aires
LR9	1,030	5,000	Radio Fenix	Buenos Aires
LR8	1,150	20,000	Radio Paris	Buenos Aires
LS2	1,190	40,000	Radio Prieto	Buenos Aires

Reception of European Stations

Reception of European stations on the broadcast band probably offers more attraction than any other field of DX-ing as the handicap is greater as the time difference is unfavorable for broadcast reception from east to west. Nevertheless European reception on the broadcast band was enjoyed by hundreds of DX-ers last winter and with the number of high power stations in Europe, and receiving sets becoming more and more selective and sensitive, it is not at all a hard thing to receive a European station in the eastern portion of North America by following our reception table. European reception usually starts about the last of November, reaches a peak in December, and gradually loses signal strength until it completely vanishes about the last of February. The central states also enjoy this field of reception occasionally, and once in a while a signal will filter through to the Pacific coast, especially in the Pacific northwest as here the signals coming over the arctic regions have less land surface to cross. European stations must be tuned for from dark to around 6 or 7 P.M., E.S.T., as at this hour most of the European stations close down for the night. You may again tune for them at around midnight or a little after as they begin to come on the air again with their early morning programmes. Saturday evenings are usually best for European reception.

Keep Records

As we go into the thick of our DX-ing season we suggest that every radio listener acquire some kind of a log hook. A notebook of some kind is usually most appropriate. This should be kept handy by your receiver for jotting down notes of interest in connection

with your DX listening. The manner in which you keep this log is a more or less personal matter, as every dyed-in-the-wool DX-er has his (or her!) own pet system. In general we suggest, in order that this log may be a valuable scientific record as well as a source of pride to its owner, that it should be kept in a neat and orderly manner. Start by jotting down at the top of the page the date. Under this heading should come a *general weather report*, consisting of a brief resumé of weather conditions at the time, including temperature, wind direction, fair or cloudy, moon or none, and if possible a *barometric pressure* reading. Below this start your actual detailed record. This usually consists of the *time* (hour and minute) in a column to the left, and a description of the station being received in columns across the page, giving *call, frequency, power* and your *dial setting*. At the right should be remarks on how the station was being received. The understandability and volume of the signal is usually recorded using the following scale for reference.

Symbols for Reception

- Q Understandability
 Q1 Not understandable
 Q2 Only a word now and then understandable
 Q3 Understandable with difficulty
 Q4 Can be well understood
 Q5 Every word easily understandable
- R Volume (Signal Strength)
 R1 Extremely weak R6 Rather strong
 R2 Very weak R7 Strong
 R3 Weak R8 Very strong
 R4 Rather weak R9 Extremely strong
 R5 Fair

Thus a station would be given a Q4/R5 rating in your log if the words were clearly understandable and possessed of a fair signal strength.

Many DX-ers prize their logs very highly. A DX-er's log is to him what the stamp album is to a stamp collector. It is his record of achievements in this fascinating pastime. Next issue we shall go a step further and describe the collecting of *station verifications*, which by many is regarded as the supreme pleasure in DX-ing.

The DX-ers' Report; Short Waves

R. H. Tomlinson, Port Chester, N. Y., writes that CP5, *Radio Illimani* is back again on 49.34 meters (6080 kc.) from 8 to 9 P. M., E.S.T. He also received a notice from HJ1ABE, Cartagena, Colombia, saying that the government had made them go back onto 49.05 meters (6,115 kc.). Station ORK, in Ruy-
 (Continued on page 368)

THE ANALYSIS OF RADIO RECEIVER SYMPTOMS

OPERATING NOTES

WHAT THIS DEPARTMENT IS FOR

It is conducted especially for the professional Service Man. In it will be found the most unusual troubles encountered in radio service work, written in a practical manner, by Service Men for you.

Have you, as a professional man, encountered any unusual or interesting Service Kinks that may help your fellow workers? If so, let us have them. They will be paid for, upon publication, at regular space rates.

CROSLY 30S CHASSIS

"SET noisy, unstable," was the report; (see Fig. 1, for circuit involved). Inadequate rating was the cause of failure of one of the two parallel 11,000-ohm stabilizing resistors; the other was charred. Both were replaced but intermittent reception still occurred. This was finally traced to an open either within the heater prong or within the base of the 27 first A.F. tube. A new 27 was in order and the set worked fine. Some months later similar complaints were received and, on test, low plate voltage and high plate current were found on the 27 detector. High plate current was due to a shorting 0.5-mf. detector cathode resistor bypass condenser giving no bias on the 27; low plate voltage was found to be due to

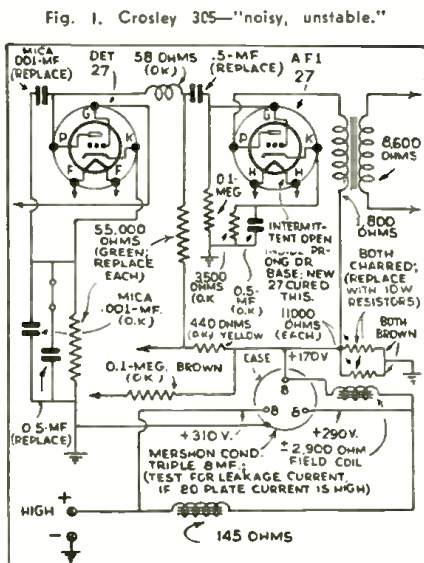

Fig. 1. Crosley 30S—"noisy, unstable."

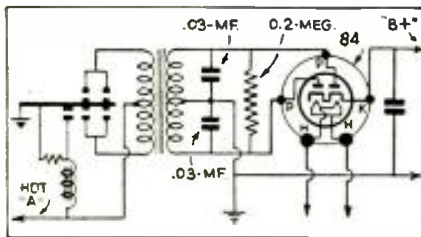

Fig. 4. R.C.A. Victor M-34 "B" vibrator repairs.

the drop in a normally 55,000-ohm plate supply resistor. Apparently, too, due to leaks, some plate current was flowing intermittently through the R.F. bypass from plate to cathode tending to further increase the apparent plate current. A leaky 0.5-mf. A.F. coupling condenser was also found. Replace the two 55,000-ohm resistors, two 0.5-mf. condensers, and the mica .001-mf. plate bypass condenser and normal operation will be restored. Check the electrolytic condenser if the 80-plate current is too high.

RATTLES IN DYNAMIC SPEAKERS AT HIGH OUTPUTS

THE writer has often run into dynamics which rattle and blast, or more properly buzz at high output levels but which are fine at low and moderate outputs. What is needed is a new spider and since this is an integral part of the assembly it is either necessary (1) to put in a new cone, (2) to use some other remedy, or (3) to sacrifice volume. The second follows as a matter of course. Due to fatigue or some other cause the spider simply

(Continued on page 372)

Fig. 2. Eliminating dynamic reproducer rattles.

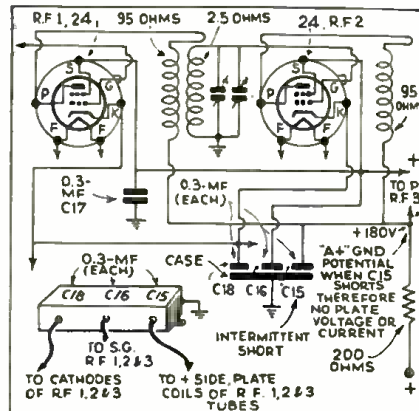
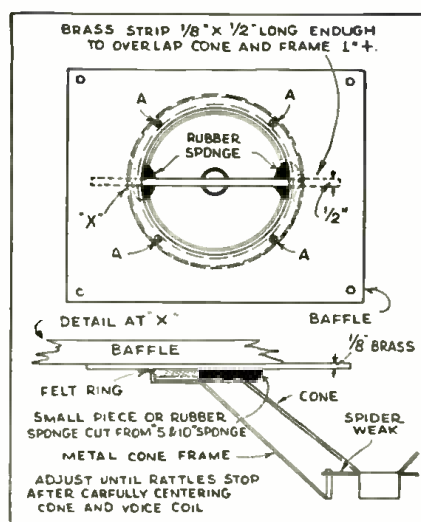

Fig. 3. Gulbrandsen 8 tube A.C. chassis.

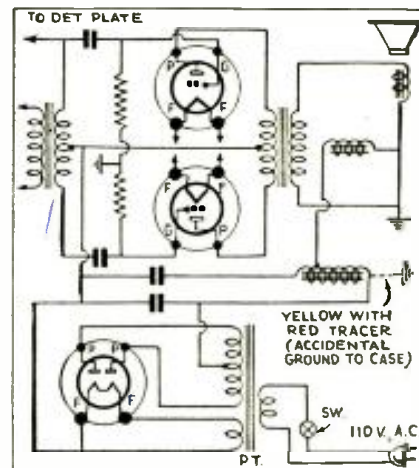
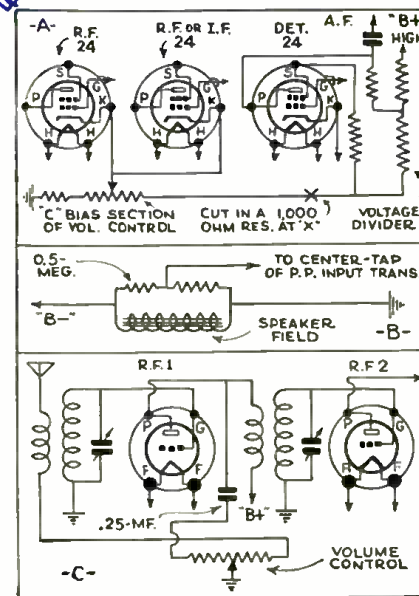

Fig. 5, above. G.E. model T-41.

Fig. 6, below. Philco—early 90s and 20s.



PHILCO MODEL 200-X 10 TUBE HIGH-FIDELITY SUPERHETERODYNE

(Frequency range: 540 to 1,720 kc.; output: 15 watts from two 42s in class A prime. Features: fidelity-selectivity control; special, high-fidelity re-producer [frequency range, 50 to 7,500 cycles], and "sound diffusing cabinet construction; bass-tone control; meter tuning; A.V.C.)

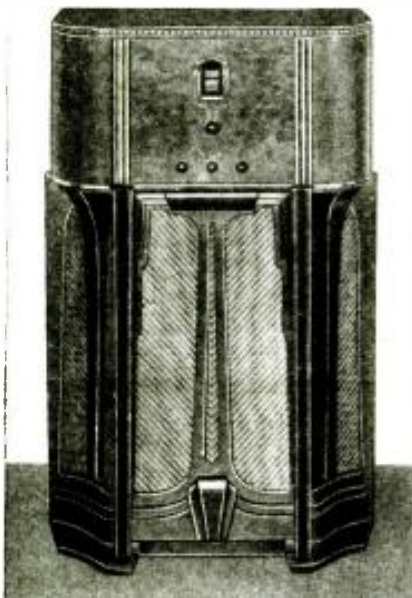

Above, Philco model 200-X High-Fidelity set. Below, location of alignment condensers.

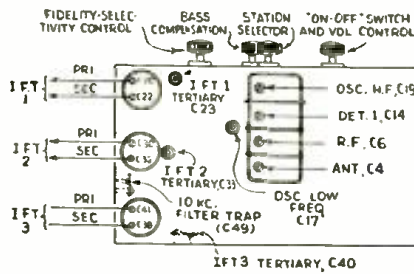

Below, schematic circuit of the 200-X.

This is the first commercial radio set designed for high-quality dual reception of standard 10 kc. broadcast stations, and the new 20 kc. "high-fidelity" stations just below 200 meters; a smoothly adjustable control varies the selectivity from "sharp" to "broad."

As the circuit of this receiver differs considerably from previous designs, a resumé of its outstanding characteristics is essential to the Service Man, and of interest to the technician.

The selectivity afforded by stage V1 eliminates image-frequency response and cross-modulation. Resistor R13, 10 ohms ("selectivity lossers 'A'") broadens, to 15 kc. selectivity, the resonance of the first-detector tuned input circuit; resistor R15, 50,000 ohms ("selectivity lossers 'B'"), performs a similar function in the oscillator tuned input circuit.

Tertiary-(third) winding trap circuits L, of I.F.T.'s 1 and 2, tuned EXACTLY to the carrier frequency, clip the tops of the resonance peaks (leaving a double-peak characteristic) by absorbing some of the energy in the low- and middle-frequency register—of the I.F.'s audio component—and thus accentuating the high-frequency register.

The degree of this absorption determines the selectivity of the circuit, and is a function of the degree of coupling between the primary and secondary windings of I.F.T.'s 1 and 2, as determined by the setting of the "fidelity-selectivity" control—resistors R24A and R24B ("selectivity controls 'A' and 'B'"), and R24C ("sensitivity compensator").

Without the resistance of R24A and R24B in the respective circuits the tertiary or trap windings L act as a heavy load across the respective secondary windings, which results in wide-band (decreased I.F. selectivity) reception and decreased sensitivity; the loss in sensitivity in this manner is then compensated simultaneously by an automatic increase in amplification, since the setting of the "fidelity-selectivity" control decreases the amount of resistance effective in cathode resistor R24C, thus increasing the gain of tubes V2 and V3.

With the resistances of R24A and R24B in circuit the trap action is very slight, and circuit selectivity and sensitivity are greatly increased.

The A.V.C. circuit controls the gain of tubes V2 and V3. The A.F. driver stage delivers power to the control grids of V7 and V8 via step-down transformer T1.

At low-volume settings of manual volume control R66A, units R73 and C76 become effective in boosting the bass-note response, regardless of the setting of tone control switch Sw. 2. At high-volume settings of R66A, units R73 and C76 again become effective in bass-note emphasis when switch Sw. 2 in position "A" shorts and grounds condensers C.

Because of the double-peak resonance and broad selectivity of the I.F. circuits, sharp'y-resonated coil LT is required, in conjunction with amplifier tube V9, in order to obtain exact mid-resonance indication of the shadowgraph meter.

Radio frequency choke R.F.C. tuned by variable condenser C49 is a 10 kc. filter. The purpose of this filter is to remove any side-bands of a signal which may be coming through from an adjacent channel and to provide clear audio reception up to 10,000 cycles. This means that the audio channel from this point onward is responsive to frequencies up to 10,000 cycles.

(Refer to RADIO-CRAFT DATA SHEET No. 128 for additional data concerning alignment procedure, and recommendations for best operation of this set—which establishes a precedent in radio receiver design.)

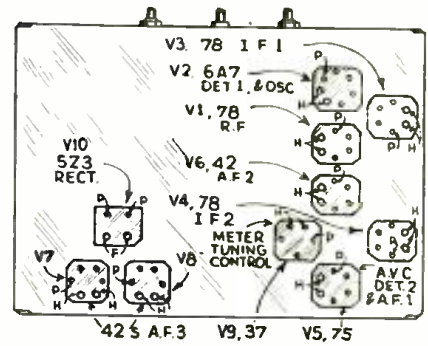

Above, socket layout for voltage tests.

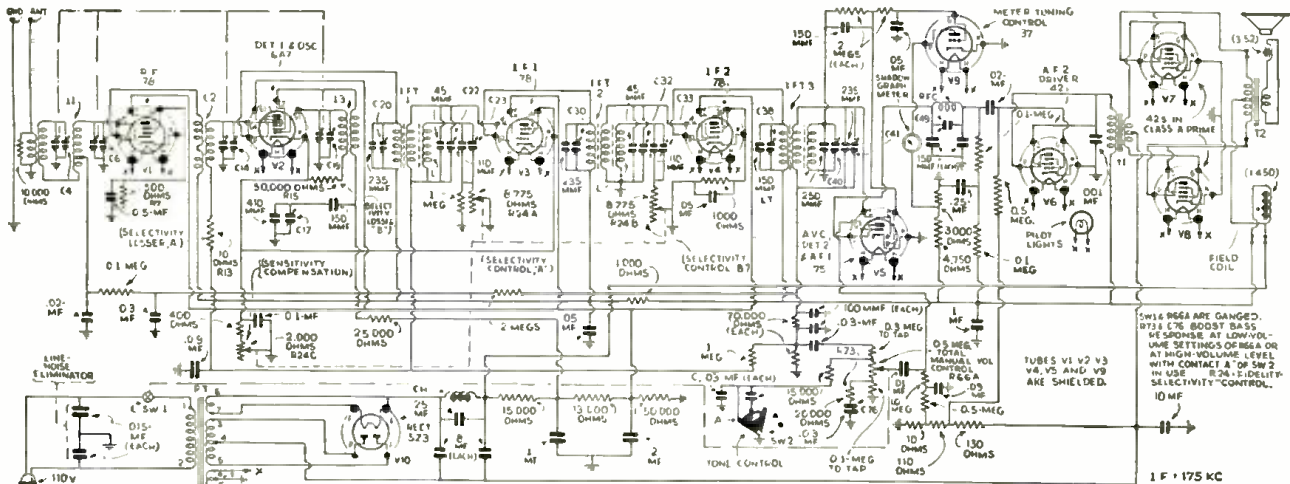

RADIO-CRAFT'S INFORMATION BUREAU

ELECTROLYTIC CONDENSERS FOR CONDENSER-START TYPE MOTORS

(298) Mr. Anthony Wade, Durham, N.C.
 (Q.) I have a small electric motor for television work, which is about 1/32 horsepower and designed to operate from 110 V. A.C. However, the tag on it indicates that it is of the "condenser-starting" type. I know very little concerning this type of motor, and inasmuch as I am desirous of using it for some experimental work because of its speed and certain other characteristics I am asking you for information which will make me more familiar with it.

What type of condenser, and what size, is necessary to start the motor?
 If of a large size, can electrolytic condensers be used?

What is the theory of operation for such a unit and, what definite characteristics are required of the condenser which must be used?

(A.) The information you desire is clearly and completely described in a recent bulletin (The Research Worker) published by the Aerovox Corporation. However, for the benefit of others who might be interested in the same subject we are herewith reprinting, by courtesy of this company, all pertinent data regarding condenser-start type motors, in addition to salient information on electrolytic condensers which are used for this purpose.

"In certain types of radio receivers, for example those designed for use on 110 volts D.C. precautions must be taken to prevent damage to the condenser in the event that the power lead from the receiver is connected incorrectly into the light socket. To prevent damage to the condenser under such conditions it is customary to use not one formed plate but to form both of the plates. When the power lead is properly plugged into the light socket and positive voltage is applied to the positive terminal of the condenser, the condenser functions like an ordinary unit. However, if the voltage is reversed, then the film on what would normally be the unformed negative foil acts to limit the leakage current. By limiting the leakage current excess heating of the condenser, which would irreparably damage it, is prevented.

Condensers which are made using two formed foils are frequently referred to as double formed

condensers since both plates instead of one plate are formed. Condensers for intermittent A.C. use are also this type, and the purpose of the double formation is to permit either plate to become positive and yet hold the leakage current to a low value at all times.

Condensers in which both plates are formed may be subjected to alternating current for short periods of time without damage to the condenser. If, on the other hand, the condenser is allowed to remain across, say 110 V. A.C. for a period of hours then the heating, due to the current, finally causes the condenser to become so hot as to ruin it.

The most general use of electrolytic condensers designed for intermittent A.C. duty is in connection with the starting of "split-phase" or "condenser-start" type of motors. For this reason this type of electrolytic condenser is called a "starting condenser." The condenser-start type motor is not a new development but its general commercial adoption was economically not practical up to about three years ago, due to the lack of suitable low cost starting condensers. The development of electrolytic starting condensers pioneered in 1932 by this company made the condenser-start motor an economically practical one to build. Today, such motors are very generally used with household refrigerators, oil burners, washing machines, and other devices requiring fractional horsepower motors where the starting service requirements are such as to permit the use of electrolytic starting condensers.

The circuit of the motor generally used with electrolytic starting condensers is shown in Fig. Q.298A. The motor contains two windings, one the main winding M, and the other the starting winding S. Connected in series with the starting winding across the line is the starting condenser C and a switch Sw. The switch is of an automatic type which automatically opens and disconnects the condenser after the motor approaches running speed. In some cases the switch is of the electromagnet type, and in other cases it is of the centrifugal type, but in either case it is the function of the switch to maintain the starting circuit closed until the motor reaches a sufficiently high speed to continue to run and carry the load as an ordinary single-phase motor.

The effect of the condenser in the starting circuit is to shift the phase of the current in the starting circuit so that for all practical purposes the motor starts as a two-phase motor with the starting torque and power factor characteristics of such motors. When the motor reaches full or nearly full speed the starting circuit is automatically disconnected and the motor continues to operate as a single-phase motor.

As mentioned above condenser-start type motors are frequently referred to as split-phase motors, since the effect of the condenser is to take the single phase current and to split it

SPECIAL NOTICE

Those questions which are found to represent the greatest general interest will be published here, to the extent that space permits. (At least 5 weeks must elapse between the receipt of a question and the appearance of its answer here.) Mark such inquiries, "For Publication."

Replies, magazines, etc., cannot be sent C.O.D. Back issues of RADIO-CRAFT prior to December, 1932, are available at 50c per copy; except the following issues: 7/23; 2, 3, 4, 6, 7, 9 and 11/30; 5, 8 and 9/31; and 10/32, which are out of print. Succeeding issues are still available at the regular price of 25c per copy.

Inquiries to be answered by mail MUST be accompanied by 25c (stamps) for each separate question; answers are subject to subsequent publication if considered of exceptional interest.

Furnish sufficient information (in reference to magazine articles, be sure to mention issue, page, title, author and figure numbers), and draw a careful diagram (on separate paper) when needed to explain your meaning; use only one side of the paper. List each question. Be SURE to sign your name AND address.

Enclose only a STAMPED and self-addressed envelope for names and addresses of manufacturers; or, in connection with correspondence concerning corrections to articles, as this information is gratis.

Individual designs can be furnished at an additional service charge. The fee may be secured by addressing the inquiry to the SPECIAL SERVICE department, and furnishing COMPLETE specifications of desired information and available data.

into two currents 90 degrees apart. If the current in the running main phase is I1, and the current in the starting phase is I2 then the phase relation of these two currents and the line voltage at the moment power is thrown on the motor is as shown in Fig. Q.298B. The phase angles of the two currents are of course merely representative of the general relation existing between these two currents and the voltage.

The important point to be noted is that in the case of the condenser start type motor as shown in Fig. Q.298A, the two currents are essentially 90 degrees out of phase with each other and this results in giving the motor the starting characteristics of a two-phase motor.

Since the condenser is in the circuit only during the starting period which is usually a couple of seconds it is customary to rate electrolytic starting condensers in terms of the number of starts per hour. Accordingly starting condensers are normally rated for service where the number of starts per hour does not exceed twenty and each start has a duration of not more than three seconds. Under such conditions of service electrolytic starting condensers have been found to perform extremely satisfactorily on tests equivalent to many millions of start-stops of a motor.

Electrolytic starting condensers can be tested by connecting them directly across an A.C. line and measuring the current; this will determine the capacity of the condenser. If the frequency of the supply is 60 cycles the current will be

(Continued on page 373)

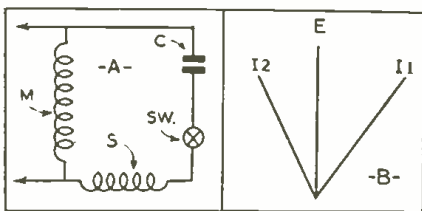

Q. 298 A and B.
 Circuit; condenser starting type motor

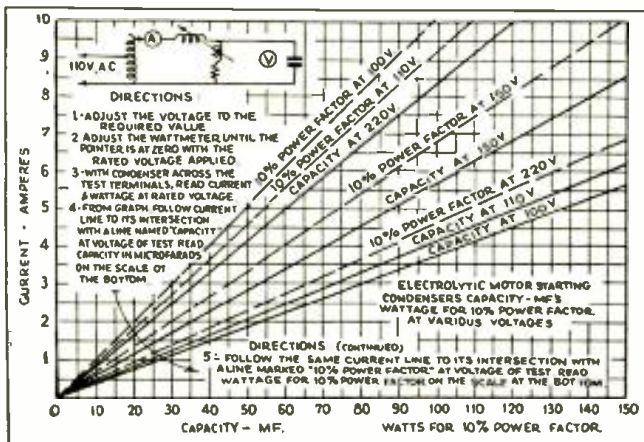

Q. 298C, left.
 Phase relation between current and capacity when motor starts up.

Q. 299, below.
 Two volt converting data.—A.K. 67.

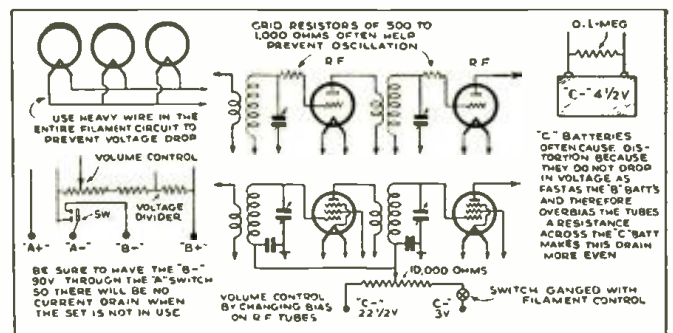

Radio Men!

**GOOD BOOKS WHICH HELP
MAKE RADIO WORK MORE PROFITABLE**

Presented on this page are books of the RADIO-CRAFT LIBRARY SERIES—a most complete and authentic set of volumes treating individually, important divisions of radio. Each book has been designed to give radio men the opportunity to specialize in one or more of the popular branches of the industry. You will find them a real help in your work and they will contribute to your money earning capacity. Read these books during your spare time at home.

The authors of these books are well-known to everyone. Each is an expert radio man; an authority on the subject—each is thoroughly familiar with the field which he represents.

This is the first real opportunity that you have ever had to build a library of radio books that are authentic. **MOST OF THE BOOKS HAVE BEEN RECENTLY REVISED AND REWRITTEN TO KEEP THEM UP TO THE MINUTE.** Mail coupon below for your books.

Book No. 1
Radio Set Analyzers
And How To Use Them
By L. VAN DER MEL

With Full Instructions and Descriptions of Set Analyzers, Tube Checkers, Oscillators, etc. (Just revised.)

Book No. 2
Modern Vacuum Tubes
And How They Work
By ROBERT HERTZBERG

With complete Technical Data on All Standard and Many Special Tubes. (Just revised.)

Book No. 3
The Superheterodyne Book

All About Superheterodynes
By CLYDE FITCH
How They Work, How to Build and How to Service Them.

Book No. 4
Modern Radio Hook-Ups
The Best Radio Circuits
By R. D. WASHBURNE

A Complete Compendium of the Most Important Experimental and Custom-built Receivers.

Book No. 5
How to Become a Radio Service Man
By LOUIS MARTIN

How to get started in the business of servicing radios and how to make money in this field.

Book No. 6
Bringing Electric Sets Up to Date
By CLIFFORD E. DENTON

With Pentodes, Multi-Mus. Dynamic Speakers—Complete Information How to Modernize A. C., D. C. and Battery Operated Receivers.

Book No. 7
Radio Kinks and Wrinkles
By C. W. PALMER

For Service Men and Experimenters
A Complete Compendium on the Latest Radio Short-Cuts and Money Savers—These Kinks Are Great Time-Savers.

Book No. 8
Radio Questions and Answers
By R. D. WASHBURNE

A Selection of the Most Important of 5,000 Questions Submitted by Radio Men During the Course of One Year—They Are All Answered by a Technical Expert.

Book No. 9
Automobile Radio and Servicing
By LOUIS MARTIN

A Complete Treatise on the Subject Covering All Phases from Installing to Servicing and Maintenance. A Book That is Greatly Needed Today. (Just Revised.)

Book No. 10
Home Recording and All About It
By GEORGE J. SALIBA

A Complete Treatise on Instantaneous Recordings, Microphones, Recorders, Amplifiers, Commercial Machines, Servicing, etc.

Book No. 11
Point-to-Point Resistance Measurements

By CLIFFORD E. DENTON
The Modern Method of Servicing Radio Receivers—a Book Which Radio Service Men Have Referred to More Than Any Other.

Book No. 12
Public Address Installation and Service
By J. T. BERNSELY

Modern Methods of Servicing and Installing Public Address Equipment.

Big Discount To You

In order to make it possible for everyone to buy these books, the fifty (50) cent price has been made uniform for all volumes. You can buy these books separately, but you should take advantage of our special offer:

When Five (5) Books Or More Are Ordered Deduct 20% From Your Remittance

Simply fill in the coupon at left, and mail it to us together with your remittance. Checks, stamps or money orders accepted.

Here are the subjects covered—

- Set Analyzers
- Tubes
- Superheterodyne Circuits
- Radio Hook-ups
- Servicing Business
- Modernizing Electric Sets
- Kinks and Wrinkles
- Questions and Answers
- Auto-Radio Servicing
- Home Recording
- Resistance Measurements
- Public Address

All Books Uniform Volumes are all uniform size, 6 x 9 inches, and contain on an average of 50 to 120 illustrations. Each book is printed on fine paper and no expense has been spared to make it an outstanding value.



CLIP—MAIL THIS COUPON TODAY!

GERNSBACK PUBLICATIONS, INC., 99 Hudson Street, New York, N. Y.

I have circled below the numbers of books in the RADIO-CRAFT LIBRARY SERIES which you are to send me, and have deducted 20% for ordering five (5) books or more. I have included my remittance in full, at the price of 50c each, when less than five books are ordered.

The amount of my remittance is.....(Stamps, checks or money orders accepted.)

Circle numbers wanted: 1 2 3 4 5 6 7 8 9 10 11 12

Name Address

City State RC-1234

Please Say That You Saw It in RADIO-CRAFT

PHILCO MODEL 200-X HIGH-FIDELITY SET—ALIGNING AND OPERATING PROCEDURE

I.F. Adjustments

In aligning this receiver an unmodulated service oscillator will be required, due to the fact that the adjustments are more critical and complicated than in conventional radio sets.

With an unmodulated signal it is not possible to obtain output indication in the usual manner. Instead, reversed action—maximum output is indicated as minimum reading—is secured by connection to the A.V.C. system. That is, connect a high-resistance voltmeter, reading 0-5 or 0-10 V., across cathode bias resistor R7; normal, no-signal reading is 3V.

After preparing the unmodulated signal generator and connecting the voltmeter as directed, proceed as follows:

(1) Set the receiver tuning dial at its extreme low-frequency position. Remove the grid clip from the cap of V2, and connect the signal generator antenna lead in its place. Connect the ground lead from the signal generator to the ground terminal of the chassis. Adjust the signal-generator frequency to *exactly* 175 kc. Turn fidelity-selectivity control R24 all the way to the left.

(2) Adjust the 6 I.F. padding condensers, C20, C22, C30, C32, C41 and C38, in the tops of the 3 I.F.T. cans, for maximum output (minimum meter reading), starting with the compensator or padder at the front of the chassis, and continuing with the adjustments toward the rear of the set. During these adjustments, the output of the signal generator should be regulated to maintain a voltmeter reading of approximately 2 V.

(3) Connect a 250 mmf. condenser from the plate of V4 to ground. This will increase meter reading to about 2.5 V.

(4) Readjust I.F.T. 3 secondary padder C41 for maximum output.

(5) Readjust I.F.T. 3 primary padder C33 for maximum output. Do not again touch the grid padder C41.

(6) Turn the fidelity-selectivity control all the way to the right.

(7) Adjust the first and second I.F.T. tertiary (third) padders C23 and C33 for MINIMUM output (maximum voltmeter reading).

(8) Leaving the fidelity-selectivity control in the right-hand position, it will be found, upon varying the frequency of the signal generator, that two definite dips will appear in the voltmeter reading—one at 167 kc. and another at 182 kc. These dips in the voltmeter reading indicate the required peaks in the tuning curve. The amplitude of these peaks *should be equal*; that is, the same voltmeter reading should be obtained at both 167 kc. and 182 kc. Any variations in these two readings can be corrected by a *slight* readjustment of third I.F.T. padder C38.

R.F. Adjustments

The R.F. portion of the receiver is adjusted as follows:

(9) Replace the grid clip on V2 and connect the antenna terminal of the signal generator to the antenna terminal of the chassis. Turn the fidelity-selectivity control all the way to the left and set the receiver dial at 1,500 kc. The same type of output indication is employed as in the I. F. adjustments.

(10) Adjust the signal generator for a frequency of 1,500 kc. Adjust the "oscillator" padding condenser C19, and first-detector padding condenser C14, for maximum output and in the order mentioned. Regulate the signal-generator output control to maintain a voltmeter reading of 2 V., as before.

(11) Turn in R.F. padder C6 until the voltmeter reads 2.5 V. and then adjust an-

tenna padder C4 for maximum output.

(12) Readjust padding condenser C6 for maximum output. Do not again touch padder C4.

(13) Set the receiver dial and the signal generator at 600 kc. Adjust the oscillator low-frequency padder C17 for maximum output. As the R.F. tuning is rather broad, there will be a considerable range on the dial that will give about the same output when C17 is adjusted for maximum output. The padder must be adjusted at the middle of the range. This point may be determined with accuracy in the following manner: Starting with the usual voltmeter reading of 2V., slowly turn the receiver dial toward the low-frequency end and, at the same time, readjust padder C17 for maximum output until a point is reached where the maximum output is indicated by a voltmeter reading of 2.5 V. Note carefully the exact dial reading at this point. Follow the same procedure while turning the dial in the opposite direction until the output reading decreases to the same value. Set the dial at the exact center of these two points and readjust padder C17 for maximum output.

(14) Adjust the third I.F.T. tertiary padder C40 to give minimum width in the shadow tuning meter in the receiver. This padder is reached from rear of chassis.

Tube Voltages

Referring to the tube socket illustration, voltages are as follows: with a 115 V. line:

Tube Type	P. to K.	S.-G. to K.	K. to Gnd.	C.-G. to K.
V1	225	80	3	0-2
V2**	210	73*	8	0
V3	210	73*	8	0-2
V4	220	76	4	4
V5	110	0
V6	225	225	0	0-2
V7	335	335	0	35
V8	335	335	0	35
V9	63	0	0
V10	350	(plate to ground)		

*G3 and 5 to K. **G1 to K., 22 V.; G2 to K., 90 V.

(Voltages as read with a high-resistance voltmeter for plate, grid and cathode tests; set dial at 55, volume control at maximum, and R24 at middle position.)

Power transformer data: terminals 1-2, white, 120 V.; 3-5, yellow, 780 V.; 6-7, blue, 5 V.; 8-10, black, 6.3 V.; 4, yellow—green tracer (center-tap of 3-5); 9, black—yellow tracer (center-tap of 8-10).

Adjustment of 10 Kc. Filter

The 10 kc. filter in the audio circuit will rarely require readjustment. As the proper adjustment of this padder, C19, requires an *accurately calibrated* audio oscillator, it should be reset only in the event that it has been tampered with or in cases where it has become necessary to replace one of the elements of this filter. An emergency adjustment of this filter can be made in the following manner:

(15) Connect the signal generator to the control-grid of V2, leaving the grid clip in place.

(16) Disconnect the voltmeter from resistor R7 and connect an output meter to the plates of the power output tubes in the usual way.

(17) Set the receiver dial at 550 kc. At this point the oscillator in the receiver will be tuned to 725 kc. The adjustment of the signal generator (switch in "unmodulated" position) to approximately this same frequency will cause an audible beat note to be heard in the speaker. By means of the signal-generator tuning control, reduce the fre-

quency of this beat note until zero beat is reached, at which point the output meter reading will decrease to 0. Turning the receiver dial now in either direction will gradually increase the frequency of the audible note so that at 540 or 560 kc. a 10,000 kc. note will be heard. At either of these points padder C49 should be adjusted for minimum reading of the output meter.

The Reproducer System

High musical notes travel much in the same manner as a beam of light. The higher the musical frequency, the more pronounced this "beam effect" becomes. (See, "Third Dimension in Music," RADIO-CRAFT, May, 1934, p. 654.) In fact, when using frequencies above 4,000 cycles, this beam narrows down to a path directly in front of the speaker cone. Consequently, an inclined baffle board is necessary in order to transmit the beam from the floor up to the ear level, so that the high notes can be heard. In the model 200-X cabinet this idea is carried further—the reproducer is mounted on the inclined baffle board, so that all of the high notes are projected directly to the ear level. Due to the use of a high-fidelity speaker *especially designed for this cabinet* the effect of these high notes is so pronounced that it is hard on the ears if the listener happens to be standing directly in the front of the undiffused beam.

In the beam, more high notes are heard in proportion to the remainder of the music than would be natural or normal in listening to the original music. Therefore, it is necessary to *diffuse* these high notes throughout the room. This desired result has been accomplished in the design of the speaker and cabinet. (See "The Problems in High-Fidelity Design," RADIO-CRAFT, December 1934, p. 339.)

Inside the cabinet, consequently, the inclined baffle board is set back beyond the grille cloth, and a "sound diffuser" is mounted directly in front of the reproducer. This sound diffuser has no effect on the low or intermediate notes, but does produce the desired diffusion with respect to the higher musical frequencies. The inclined baffle board raises the high notes to the ear level, and the sound diffuser does the rest by spreading the additional high notes all through the room so that no matter where the listener is sitting he gets the correct proportion of high, low and intermediate notes. (Incidentally, the diffuser also includes a *transverse* reflector which acts to project the correct proportion of high-frequency notes to the ear of the person tuning the receiver.)

To get the full benefit from the acoustic design of the 200-X, the set should be placed across a corner of the room, or at an end of the room where the reproducer is unobstructed by any large piece of furniture.

Chain programs are often sent over land wires which may be limited to 5,000 cycles, but even on this frequency the 200-X gives noticeably more natural reproduction. Such chain programs, however, may be heard with full 7,500 cycle fidelity when picked up on the station originating the broadcast and when not too far away from it.

High-fidelity reception may be obtained from certain stations in the daytime when signals from distant stations on adjacent channels are too faint to interfere. At night, however, the adjacent-channel signals may be strong enough in some cases to cause interference if full high-fidelity reception is attempted; to eliminate this, merely readjust the fidelity-selectivity control.

(See Radio-Craft Data Sheet No. 127 for circuit, and socket and condenser layouts.)

HOW WHAM GOES "HIGH FIDELITY" John J. Long, Jr.

WITH "high fidelity" being acclaimed as "the greatest advance in radio since the invention of the vacuum tube," it is worthy of note that high-fidelity receivers are an economic waste *unless there exists high-fidelity broadcasting.*

Probably the first of existing stations in the broadcast band of 200 to 550 meters to extend its entire facilities is radio station WHAM. (This station, located in Rochester, N.Y., is owned and operated by the Stromberg-Carlson Co.)

At present Rochester's "50,000 watter" is installing new line, studio and monitoring amplifiers, and rebuilding its studio-transmitter telephone circuits to accommodate an increase in frequency range from 30 to 5,000, to 30 to 10,000 cycles.

NBC's new Radio City installation is "high-fidelity" and line facilities from New York to Rochester were designed to pass all frequencies from 30 to 8,000 cycles, so when the changeover is complete WHAM will be able to boast of "high-fidelity" throughout its daily 16 hour schedule.

The Western Electric 50 kw. transmitter which was put into use in 1933 is designed to handle all audio frequencies required by the most exacting standard. It has a capability of 100% modulation over the range of 30 to 10,000 cycles, and the modulation characteristic over a range of 40 db. is well within 2 db. The noise level below 100% modulation is minus 62 db. The use of a cathode ray oscilloscope together with standard level measuring equipment will enable us to maintain the transmitter up to this new standard.

In the studio control rooms have been installed new W.E. high-fidelity amplifiers capable of passing all frequencies between 30 and 10,000 cycles with a deviation of less than 2 db. and less than 1% harmonic distortion.

Telephone lines connecting control rooms with the transmitter are being changed to carry the wide frequency range without a deviation of more than 1 db. Short lines used for broadcasts outside the studios may be equalized to cover the range without a deviation of over 2 db. The portable field amplifiers are capable of wide-range reproduction, use W.E. dynamic microphones, and are completely A.C. operated.

In a high-fidelity system there are several requirements which must be met if the full efficiency of the system is to be realized, as follows:

- (1) Program material must be of high calibre.
- (2) Studio acoustics must be correct.
- (3) The microphone must be free from peaks and be capable of wide-range response.
- (4) Audio amplifying equipment must be of wide-range type, offer very little distortion, and be inherently quiet.
- (5) Telephone circuits must be equalized for wide-range operation and have a low noise level.
- (6) The transmitter must be capable of faithful reproduction, and must not distort audio frequencies either in amplitude or by the addition of spurious frequencies generated by the transmitter. The noise level must also be inherently low.
- (7) A high signal level must be maintained at the receiver input, to override any atmospheric noise which may be present.
- (8) The entire receiver must be designed for high-fidelity reception and use a loudspeaker system capable of reproducing all of the required frequencies faithfully both in amplitude and range. The noise level in the receiver must be as low as in any other part of the system.
- (9) The acoustics of the room in which the receiver's loudspeaker is located must be reasonably good.

In conclusion, it is apparent that the broadcaster's effort to perfect his transmission will go for naught unless the public cooperates by demanding receivers capable of reproducing all that the transmitter puts on the air.

Chief Engineer, Station WHAM.



SERVICE MEN SAY—

**YOU DON'T HAVE
TO "BABY"
BURGESS
BATTERIES**

**You Can Use Them
7 or 8 Hours a Day
and Get FULL Service!**

It is no longer necessary to use battery operated sets only a few hours a day to get full service from your batteries. BURGESS engineers have proved—by many tests in our laboratory and in actual use—that you can operate a set equipped with BURGESS Batteries seven or eight hours a day and get the same number of hours of service!* You don't have to "baby" BURGESS Batteries. They are built to stand the gaff!

**Dependable DRY "A" Power
at Less than 1¢ an Hour!**

Distinctly a BURGESS development, the POWER HOUSE is a 100% DRY "A" battery designed for use with 2-volt sets. It costs only \$3.20 and delivers 400 hours of dependable service. It is compact, weighs only 14 lbs., requires no attention, is not affected by weather. The POWER HOUSE will deliver every hour of service we've built into it even when used for long periods each day.



**World-Famous BURGESS
"B" and "C" Batteries**

BURGESS Batteries have been taken to the North and South Poles and all around the world by explorers who would have only batteries built to "take it" hour after hour without any decrease in the total hours of service delivered. Recommend BURGESS Batteries, and as owners of battery operated sets enjoy more programs per day they will thank you. BURGESS BATTERY COMPANY, Freeport, Ill.



* Economical operation of 7 to 8 hours a day depends, of course, on the set being powered by batteries of the proper capacity.

BURGESS
BATTERIES AND FLASHLIGHTS

Please Say That You Saw It in RADIO-CRAFT

MANUFACTURERS of QUALITY RADIO SUPPLIES

Below are listed but a few of the hundreds of products which we manufacture . . . all typical of the values which we offer.

Service-men, Amateurs and Experimenters know that ICA stands for QUALITY. Insist upon ICA products for reliability and dependability. The list prices shown are subject to a discount of 40% when purchased thru your Jobber or favorite Mail Order House . . . or send your order direct naming Jobber and we will see that you are promptly supplied.

S. W. COILS WOUND ON LOW LOSS SMALL BAKELITE RIBBED FORMS

4 prong, 2 windings, 4 coils cover 16-217 meters. Have low-loss wire for primary and tickler. Will tune with 110 mfd. condenser. List price \$1.90.



NEW ALL WAVE DOUBLE DOUBLET ANTENNA

New type noise reducing system for all-wave and short wave receivers. Big improvement over ordinary doublet antennas. 60 ft. span. List price \$5.50. Special 34 ft. span where there are space limitations. List price \$6.00.



NEUTRALIZING AND ALIGNING TOOL KIT

With carrying case. Includes every possible combination of convenient neutralizing tools which service men MUST have. 12 separate and distinct telescoping parts some of which can be used for several operations. Supplied in black leatherette vest pocket case. List price complete \$4.00.



RADIO SCREW DRIVER KIT INSULOID HANDLE

Five special, bi-carbon steel radio screw drivers. Insuloid handle permits positive insulation and grip. Just what every serviceman, amateur and experimenter needs. Sizes: 4 1/2 x 1 1/4", 6 x 1 1/2", 7 1/2 x 1 1/2", 8 1/2 x 1 1/2", 10 1/4 x 1 1/2". List price complete with leatherette case \$1.75.



LOCK-SOCKET WRENCH and SCREW DRIVER SET

Just what the radio serviceman or fan needs. Consists of 11 parts. High-grade steel, radiating plated. Screw driver and handle, hex handles and extensions and socket wrenches. 1 1/4", 3/16", 11/32", 3/8", 7/16". Also 1 knurled socket wrench to fit 3/16" to 3/8" double hex nuts. List \$2.00.



NEUTRALIZING TOOLS, SCREW DRIVERS AND WRENCHES Fully Insulated

Complete as above \$2.75
Majestic Attachment for No. 101920
Crosley Attachment for No. 101920



BIG NEW CATALOG

Just off the press! Send 10c stamps or coin to cover cost of handling and mailing. Lists hundreds of parts, accessories and receiver kits. **BIG SHORT WAVE SECTION!**

INSULINE CORP. of AMERICA
23-25 Park Place Dept. C-124 New York, N. Y.

LATEST IN TELEVISION

(Continued from page 331)

vibration, which in turn insures a steady and clear picture. The stability of the machine is demonstrated in Fig. E. Running at full speed a coin remains balanced without rolling or falling off. On the extreme upper left of this photo can be seen an exciter lamp for the sound track of the film which permitted sound accompaniment with the pictures at the demonstration. Next to it can be seen the 6 V. automobile headlight which is the only source of light employed in scanning the picture to be transmitted. The light from this lamp is focused on the respective scanning disc mirror-lens as the lens approaches into the path of the rays. The scanning disc lens then converges the beam to a pin point on a portion of the picture frame. Dark or light exposures on the film modulate this point of light as it passes through on its way to a photoelectric cell. From then on, it becomes a question of amplification (where the receiver is tied to the transmitter by means of a transmission line) to bring the impulse back of sufficient strength for receiving purposes.

At this point we again find proof of the remarkable brilliance and ingenuity of Mr. Peck's inventive ability. A satisfactory and efficient amplifier for television purposes must have a substantially flat characteristic from 10 to approximately 50,000 cycles (depending upon the number of scanning lines) to permit the attainment of clarity and detail in the pictures. In other words the same degree of amplification must take place at 10 cycles, as at 1,000 or 50,000 cycles. Hitherto this "straight-line" amplification has been thought only possible with the "resistance coupling" type of amplification. Certainly no radio engineer has ever deemed it possible to obtain such wide-range and straight-line amplification from "transformer coupling." And yet, Mr. Peck has designed transformers, which he employs in his receiving amplifier (shown in Fig. C), which have an absolutely flat characteristic up to (and possibly over) 150,000 cycles. As a matter of fact, to doubting Thomases, he states that Bureau of Standards tests confirm his claim in tests and measurements which they have made up to 70,000 cycles, which was the limit of their measuring equipment. By using transformers of this design a more efficient and stable amplifier is possible, all of which, of course, results in an improved picture.

Vertical scanning at the transmitter of this system is accomplished by the continuous motion of the film; horizontal scanning, by means of 20 tubular mirror-lenses arranged in a completely closed circle and rigidly mounted in a scanning disc directly connected to the shaft of a synchronous motor rotating at 3,600 r.p.m. One end of each tubular mirror-lens of molded glass is silvered on one end, as shown at A in Fig. H. This construction has a number of advantages.

Vertical scanning at the receiver is secured by loosening one screw and tightening another to rock in its mounting one of a series of half-round mirror-lenses in order to change the angles of incidence and reflection (The flat-surface area of these mold-d glass mirror-lenses is silvered, as shown at B in Fig. H.); horizontal scanning is obtained as the mirror-lenses, 60 in number and arranged in a completely closed circle, are rotated at 1,440 r.p.m. by direct connection to the shaft of a synchronous motor.

Kerr Cell Modulator

The light for the image, which is projected on a screen to total 14 ins. square, is also obtained from a 6 V. automobile type lamp. This is the only source of light in this television receiver and accounts for the black-on-white picture. The beam of light from this lamp is modulated by a cell of the Kerr type (but considerably improved by Mr. Peck), shown in Fig. F, with remarkable efficiency, then focused on the mirror-lenses of the scanning disc which, by adjustment of two screws that "rock" each lens, directs and projects the spot of light to its proper position on the white screen. As previously mentioned, the size of the image is 14 ins. square, which is more than satisfactory for home use.

At the recent radio show held at Madison Square Garden in New York City, Mr. Peck had the equipment set up in a booth and entertained visitors with television demonstrations of newswreels. Despite numerous difficulties due to the location and hasty installation, the audi-

ence was more than agreeably surprised by the clarity and detail of the "received image." Transmission, of course, was done from an adjacent booth. Synchronization was almost perfect, and the results, even at the show, were far superior to any other equipment that had ever been demonstrated.

This television system may be operated in one of two ways. First, it may be arranged, as at the original demonstration, for direct-wire operation, utilizing one "television transformer" for matching into, and another out of, a 500 ohm transmission line. Using this system, a single, centrally-located transmitter could be used to energize several hundred receivers at remote points (as in a school or hotel, for instance). The accompanying sound is transmitted over a second, 500 ohm transmission line.

In the second, or "radio" system the television transformers are not required, inasmuch as the transmitter, in this instance, modulates the output of the radio station, and the signal picked up by the tuning unit of the radio set feeds into the "Kerr cell modulation amplifier" by means of resistance coupling from the detector stage of the tuner. Synchronization between transmitter and receiver is obtained, in both instances, by operating the transmitter and receiver scanning disc motors from a 60 cycle supply having the same phase. (Operation in this manner would be particularly convenient within the confines of individual cities, utilizing a wavelength of, for example, 5 meters in order to limit the range of the transmitter.)

It is understood (at the time that this is being written) that more highly perfected (and efficient) equipment is being manufactured now and will be ready for sale shortly. An increase in the number of television transmitting stations and studios would do much towards placing this new radio development on a level almost equivalent to musical broadcasts—and in a short time, too, if given a chance.

BERLIN RADIO SHOW

(Continued from page 335)

9 watts output. Perhaps the most novel part of this set to American readers is the extreme style of the cabinet and the unusual drum dial. The latter is a full vision affair with the names of the stations recorded directly. In Europe, it is customary to identify a station by the city in which it is located, rather than by the call letters as used by American stations.

The second set, shown at Fig. C, is a combined radio and phonograph. The receiver contains four tubes, has three wave ranges, contains 6 tuned circuits which supply an effective selectivity of 9 kc., employs iron core coils and has an output of 3.5 watts. The cabinet, when closed follows the severe lines of ultra-modernism found almost universally in the new sets at the Berlin show.

The third set is also notable for its cabinet and dial. In this case, the dial is a pretentious unit which records the stations not only by their locations or cities, but also by frequency. The latter reading is obtained from the circular scale

Fig. G
Control your radio set "by the clock."

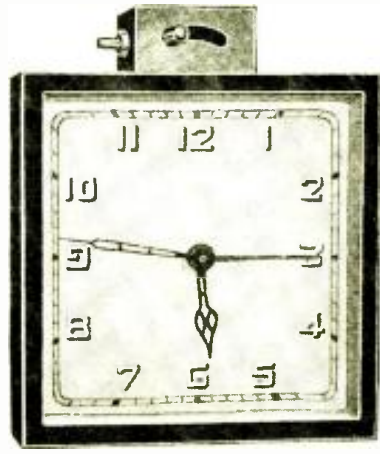

Please Say That You Saw It in RADIO-CRAFT

at the bottom of the dial. A tuning meter is also included, for convenience in tuning.

Coil Developments

This year, at the Berlin show, there is a widespread use of iron-core coils, which last year were seen only in a few models. This is shown by the receivers mentioned above, two of which employed metallic cores.

The following iron-cored coils are used in German receivers: Ferrocart coils (Goerler), Sirufer coils (Siemens), H-coils (Telefunken) and Dralperm coils (Dralowid). Also, some special coils of the Stassfurt Company, while the firm Mezso, of Munich, produce an iron core which can be moulded like beeswax into any desired shape.

The writer cannot help but digress long enough to remark that if the last mentioned cores become generally popular in manufactured sets, Service Men will work with modeling tools (as used by sculptors) instead of the aligning wrenches and insulated screwdrivers now in vogue.

The coil assembly shown at Fig. E, is the triple wave-band unit used in the new Siemens receivers. This coil assembly, it will be noted, is a combination of air-core and iron-core coils: the long-wave coil has an air core, and trimming is accomplished by the position of the copper disc (it will be noticed that this is the system used years ago by Hugo Gernsback in his Peridyne receiver). The medium-wave or broadcast band coil is an iron core inductance of the Sirufer design, using a trimmer made of the same material. The short-wave inductances are a compromise between air-core and iron-core types, as the trimmer of Sirufer material projects well into the core of the coils, and thus increases their inductance values materially.

The coil shown in Fig. F is a type of all-wave coil system which has been introduced at the Berlin show and which will probably find favor with radio constructors, there, due to the short leads facilitated by the unusual switching system used. Types of these coils are available to cover all wavelengths from 10 to 2,000 meters.

A Switch Clock

The interesting little clock shown in Fig. G contains a synchronous motor for operating the clock mechanism, and a flexible switching device, operated by the clock, for turning on radio sets or other electrical appliances at any predetermined time and turning them off when desired.

The last of the illustrations shows an unusual type of line voltage adjustment used in one of the radio receivers shown for the first time at the Berlin Radio Show. A moulded case clips on the back of the set and inside of this case, a small plug is found which may be inserted in one of five jacks for different line voltages from 110 to 240. When the insulated case is removed from the set, the current is automatically cut off from the receiver.

Only a very few of the interesting units exhibited at this show have been shown here. Lack of space rules that we must leave out many unusual and new devices. However, it is hoped that from these few examples, the trends in design in Germany can be generally understood.

Fig. H

A novel line-voltage compensator.

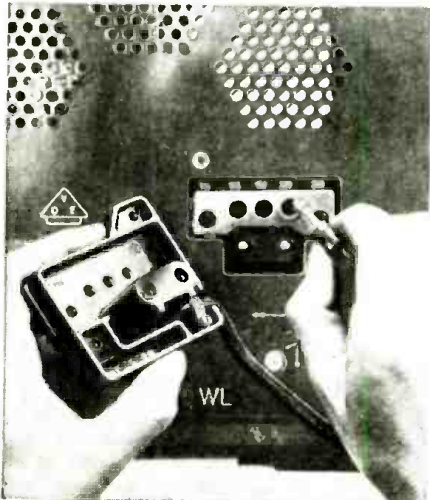



Individually TESTED for NOISE

Shhh! Shhh!

QUIET

Please!

ELECTRAD Perfects a QUIET VOLUME CONTROL

Built on a Radically New Engineering Principle

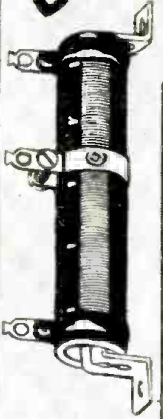

VARIOHM

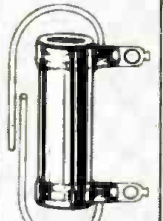

IO-WATT

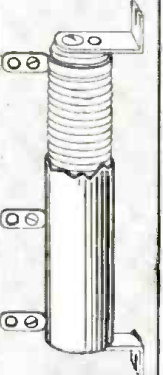

TRUVOLT

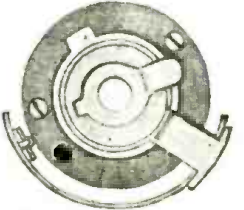

Contact glides over resistance element in straight path.

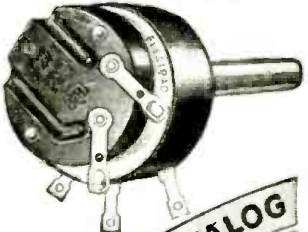

Standard Replacement Volume Control with power-switch attached.

FOR the first time, absolute quiet, smooth, positive control of radio volume is accomplished. Electrad's new 16-feature Volume Control is **GUARANTEED QUIET**—and its quietness and smoothness *increase with use*. A radically improved engineering principle assures even distribution of current around the flat outer rim of a Bakelite ring, over which gently glides a floating contact of special alloy, tracking perfectly with the baked-on resistance element.

The molded Bakelite case with metal end cover projects, when mounted, only 1/2 inch back of panel. Loosening a single screw removes the end cover and a new type power switch (approved by underwriters) may be instantly attached. The shaft is extra long aluminum. Cuts easily—saves time. All standard values available.

Special descriptive folder **FREE** on request.

from
RESISTOR Headquarters

MAIL COUPON FOR 1935 CATALOG

ELECTRAD Inc.
175 Varick St.
New York, N. Y.

Please send new 1935 Resistor Catalog. Check here for folder on new QUIET Volume Control.

175 Varick St., New York, N. Y.
ELECTRAD INC.

Name

Address



It's a natural . . . this new RADIOHM with or without complicated testing apparatus . . . is still the best.

As smooth as a baby's skin . . . and as efficient as twenty years of laboratory work can make it.

No wonder the majority of service men use CENTRALAB'S exclusively . . . and a mere handful give you practically every resistance combination you will ever need.



Every Radio Service Man should be a member of the Institute of Radio Service Men

CENTRAL RADIO LABORATORIES MILWAUKEE

Centralab
CENTRAL RADIO LABORATORIES
MOTOR RADIO NOISE SUPPRESSORS

FEDERAL MICROPHONES

Model

"B"

\$5.00

NET TO TRADE

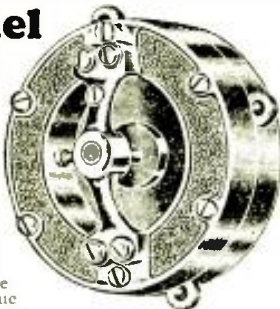

Here is the biggest value ever offered in commercial type microphones. Large two button rugged constructed microphones designed for broadcasting, short wave work, public address systems, recording, etc. Has frequency response 30 to 5000 cycles, pure gold contacts throughout, size 2 3/4 in. thick by 3 1/2 in. dia. Furnished either 100 or 200 ohms per button, weight 1 3/4 lbs. Polished chromium finish. A microphone that you will be proud to own.

Dealers! Servicemen!

The Most complete line of Public Address Equipment, Short Wave sets and accessories, Radio Replacement Parts, latest type receivers and complete service men's necessities.

Write for our new 104-page Catalog—FREE.

Baltimore Radio Corp.
721-C Broadway, New York, N. Y.

THE PROBLEMS IN HIGH-FIDELITY DESIGN

(Continued from page 339)

audio amplifier section of the radio receiver, but rather in the radio-frequency section. Also in the present method of broadcasting, most stations are not equipped to broadcast programs with "high fidelity." It should be remembered that, previously, broadcast stations were allotted transmitting frequencies on the basis of so-called "10 kc. separation." In other words, they were not permitted to deviate more than 5,000 cycles above and below their assigned frequency (wavelength). In simple language this means that the modulator and amplifying equipment must be such as to eliminate frequencies above 5,000 cycles, since if their equipment permitted frequencies above this limit to be modulated upon their transmitted wave the stations would be operating in excess of the 10 kc. limit and consequently interfering with the transmission of the station whose assigned frequency was closest to it.

Another point that must be considered, and which has seriously hampered the possibility of high-fidelity performance in previously designed receivers, is that of the R.F. amplifier section of the radio receiver. The reader will recall the oft heard and repeatedly advertised phrase "absolute 10 kc. separation." This meant that the selectivity characteristic of the receiver was such that each tuning circuit was peaked to a sharp cut-off 5,000 cycles each side of resonance. This characteristic was ideal in previous years when selectivity was highly desirable and the interference between stations was a factor which the average listener desired to eliminate. However, when we consider that this 5,000 cycle limit does not permit the reproduction of 2,500 additional cycles which are so highly necessary for high-fidelity reproduction, we find that selectivity and high-fidelity conflict.

In view of this important fact, the problem arises as to how then will it be possible to employ a high-fidelity receiver to the extent that no reception interference is obtained to mar the program? The answer is that only in so far as long-distance reception is concerned will the poor selectivity factor in a high-fidelity receiver impair its efficiency. We say this with consideration of the fact that usually 80% of the radio listeners pick up only the programs of local stations (within the radius of 100 miles), and since it is well known that the separation between local stations is at least 50 kc., no interference trouble need be encountered on local reception, and because of this 50 kc. separation between local stations not only can a high-fidelity receiver be designed to include the 2,500 additional cycles, but the increase can be made as high as 25,000 cycles if so desired, thus resulting in a receiver of absolute high-fidelity characteristics for local reception only.

All these facts may not keep the doubters quiet. They might point out that the new high-fidelity receiver is not a sensitive "DX" set, and for that reason nobody would like to possess such "inefficient" apparatus. They would be absolutely right, if radio engineers had not devised a new circuit system, and a new kind of I.F. transformer whose frequency range can be very easily "narrowed" from 7,500 cycles to about 2,000 cycles. This is especially useful where it is necessary to separate a certain far-distance station from several powerful nearby stations.

New I.F. Transformer Design

The newly-designed I.F. transformers (see Fig. 1) have the usual tuned coils A and B (primary and secondary) and in addition (far different from the conventional design) a third coil "C". When the entire resistance of R1 is put in the circuit of coil C, the coil does not absorb much energy from A and B. In other words, high gain and great selectivity exist.

But when the resistance of R1 is decreased, coil C absorbs energy from B and A. This reduces the gain and the selectivity of the circuit. The response curve becomes flatter and flatter, and allows frequencies up to about 7,500 cycles to be passed. The decreasing of the variable resistor R1 brings about a reduction in selectivity. This reduction is compensated for by a decrease in the pentagrid converter and first I.F. stage bias through adjustment of R2 and R3. Both tubes have a variable-mu characteristic. It is well known that a small variation of the bias changes the output of a variable-mu tube, and so changes the circuit selectivity.

A very simple method is used to synchronize the decrease of the bias for both tubes with the variation of R1 (the so-called "high-fidelity" control resistor). The bias control resistors R2 and R3 are ganged with the 8,775 ohm unit R1. (To the same shaft there is also attached a second, 8,775 ohm resistor. It controls a similar coil "C" in the second I.F. transformer. No variable bias control resistor is used for the second I.F. tube however.) This network of resistors and the extra coil in each I.F. transformer are the important part in the entire system. They insure nearly perfect control of selectivity when the I.F. transformers are adjusted for maximum or minimum range.

A Special Tuning Meter Circuit

It is also well known as to how critical the tuning is with a conventional superheterodyne. But to get the maximum resonance point by working within the 2,000 cycle range without a tuning meter seems almost impossible. That is the reason why we shall find in all high-fidelity sets an especially high-quality tuning meter. This tuning meter will be driven (in most cases) by an extra tube. If the second detector were used to drive the tuning meter, as is usually the case, the indicated resonance point would depend on the fidelity control setting. Hence, the design radio engineer had a good reason for deciding to use a special tube with a complete circuit for this purpose.

Something About Rectification and Distortion

The method of coupling between the last I.F. circuit and the second-detector, and further the coupling between the I.F. circuit and the tuning meter circuit, is most interesting in high-fidelity sets. This coupling is a real I.F. voltage potentiometer, since it will regulate the I.F. energy to the diode second-detector. However, its main purpose is to reduce the distortion of the set. For this same reason there is no use for the so-called square-law detector, because it has too much noise and too much second-harmonic distortion, and it is replaced by a linear diode. But, diodes are non-linear too at small inputs. They need a high input to work without distortion. However, in all advanced models, sufficient I.F. energy is easily available. In fact, it is found, sometimes, that this input is even too much in spite of the A.V.C. stage, and the first A.F. tube then becomes overloaded. In cases of this sort a new source of distortion is created, in spite of the fact that so much attention was given to the construction of a linear rectifier stage. All this trouble can be eliminated if the tuning meter circuit is used as an I.F. potentiometer. (See Fig. 2.)

The Audio Frequency Stage

It is not a secret that most of the distortion in the majority of the sets upon the market today originates in their A.F. stages. To be below the 5% distortion limit, it is necessary to design the A.F. stages with great care. The first A.F. tube must not be allowed to overload, and in the output stage there should be only used a push-pull arrangement. Because of the desire to minimize distortion as much as possible in high-fidelity receivers, we find the use of triodes in the power output stage imperative. Generally, the A.F. arrangement will comprise, a 56, as the "driver," and in the push-pull stage two 2A3 power output triodes follow. Between the second-detector and the driver a filter is included which sharply cuts off any frequency response above the limit of 7,500 cycles. Sometimes this filter network is variable and can be used to fan out either bass or treble response to suit the taste of the listener, or the acoustics of the room.

The Audio Frequency Transformers

It is not necessary to say that high-fidelity audio transformers are required in a high-fidelity receiver. The new A.F. transformers are uniform in response from 40 to 12,000 cycles. The cores are very often made of "Hyperm," a nickel-iron alloy with an extremely high initial permeability. This alloy is also used for the shielding case, affording a maximum of shielding with a minimum of size and weight. A plate bypass condenser is employed to tune the primary windings to some low frequency (about 50 cycles) so as to render prominent the low-frequency response.

The New Loudspeakers

At the beginning of this year it seemed that the horn speaker would again come into prominence. But at the present time this type of

Please Say That You Saw It in RADIO-CRAFT

speaker does not seem to be extensively used in the new high-fidelity sets. It may be that the horn speakers will come back next year. A reason for not using horn speakers to accentuate the "highs" may be the sharply-calculated list price of the new sets, and also a new method of producing a better radiation of the high frequencies without a horn. (See following paragraphs.) At any rate it seems that the dynamic reproducer with two directly radiating diaphragms will predominate in the fight this year at least.

There are now some "duo-unit" speakers on the market, which employ two cones, a small and big one. The small one radiates the high frequencies, and the larger cone the corresponding lower frequencies. However, the quality seems to have been unsatisfactory, since until now there has been no attempt by radio manufacturers to commercially employ these duo-unit speakers.

At present the new dynamic speaker with the enlarged cone is preferred to the duo-speaker system.

The reason for this enlargement (10 to 12 ins. diameter) is to raise the air-load of the cone. By this we get higher efficiency and a partial elimination of some distortion. The voice coil of these new speakers is very interesting. It is wound of aluminum wire; this construction reduces the weight—in so doing it serves to boost high-frequency radiation. The cone itself is made of two different kinds of paper. (See Fig. 4A.) For the part close to the voice coil (the so-called apex) a stiff material, especially adjusted to obtain strong radiation of the "highs," is used. The outer edge is made of a lighter paper having greater flexibility.

Increased High-Frequency Radiation

It is a well-known fact that a great many dynamic speakers radiate the frequencies above 2,000 cycles but only within an angle of about 20 degrees of the cone-axis. (See Fig. 4B.) In other words the high frequencies efficiently radiate only straight out from the cone-center, but very little radiation being obtained in other directions. In some of the new high-fidelity receivers, however, we find, in front of the cone, a "diffuser" to spread the high frequencies around the room. These "diffusers" (see Fig. 5A) are made of iron sheet of simple angular formation. The length of the diffuser-vanes has to be in a certain relation to the cone-diameter and to the highest frequencies which are intended to be radiated with high efficiency. Parallel to the diffuser-vanes are arranged two vertical straightening fins to produce both lateral radiation and diffusion of the high frequencies. (See Fig. 5B.) Sometimes we find below the diffuser-vanes a single horizontal iron wing with a slight upward angle arranged to produce sound deflection in a direction upward from the cone.

Iron Sheets or "Dead" Material?

The construction of the diffusion vanes and fins involves the question of the material to use for this purpose. While it is much cheaper to use sheet iron, acoustically it seems much better to use a material that is practically sound dead

Fig. 5

How "diffusers" increase radiation.

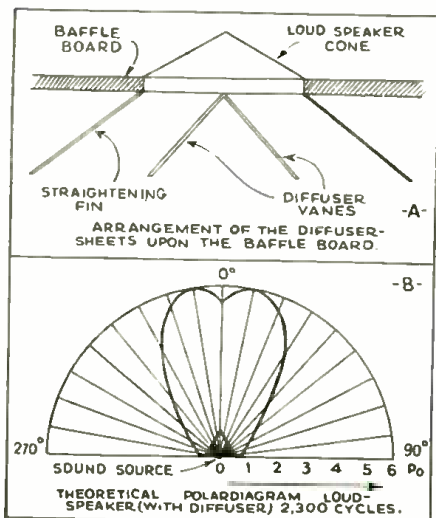

Master INTERCHANGEABILITY

By **TRIPLETT**

TRIPLETT interchangeable Master Units make possible different combinations of test equipment . . . a complete tester for every purpose. Units may be used as furnished, or placed in convenient portable cases holding one, two, three or four units. A counter case is furnished for the tube tester unit.

Triplett instruments are recognized standards. They are reliably accurate and dependable in performance. These new Master Units typify Triplett adaptability to meet every servicing requirement.

TRIPLETT MASTER TEST SET No. 1205 includes VOLT-OHM-MILLIAMMETER No. 1200, FREE-POINT TESTER No. 1220, ALL-WAVE SIGNAL GENERATOR No. 1230, TUBE TESTER No. 1210. Complete in Portable Case No. 1204. Dealer's net price

\$71³³



One Unit Portable Case No. 1201
Takes Any Master Line Unit Case Only. Dealer's net price \$4.00

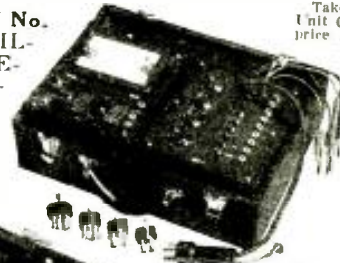

Two Unit Portable Case No. 1202
Takes Any Two Master Line Units Case Only. Dealer's net price \$4.67

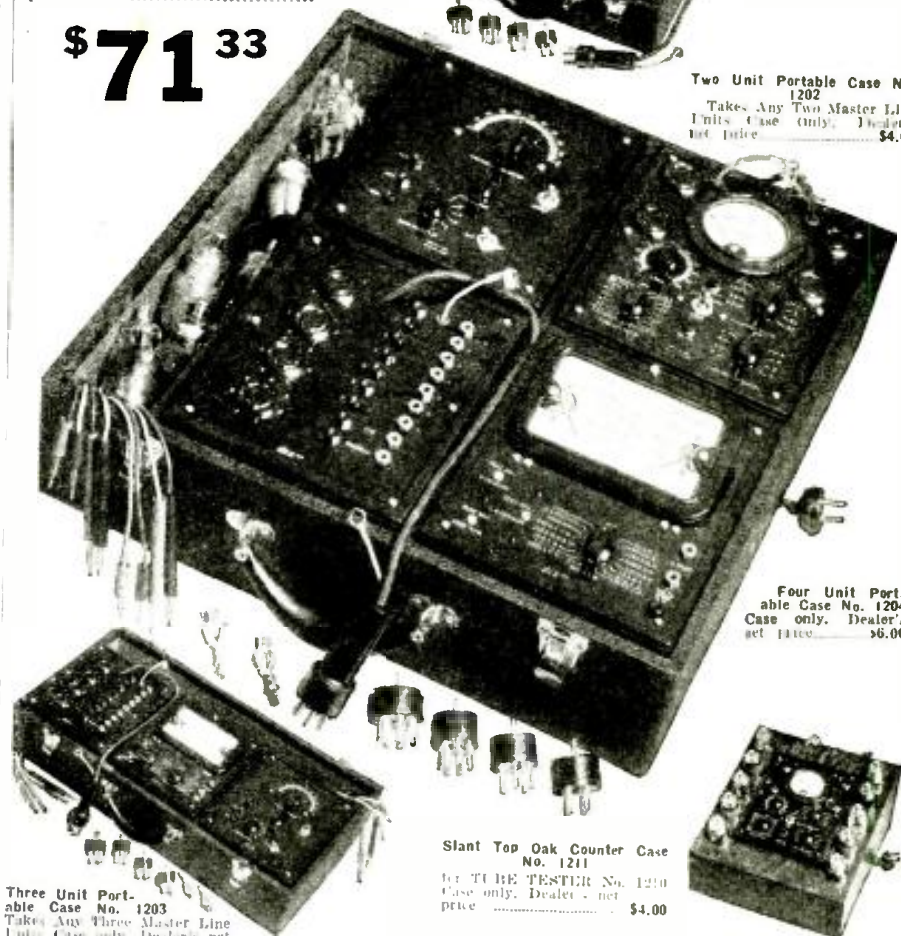

Four Unit Portable Case No. 1204
Case only. Dealer's net price \$6.00

Three Unit Portable Case No. 1203
Takes Any Three Master Line Units Case only. Dealer's net price \$5.33

Slant Top Oak Counter Case No. 1211
TUBE TESTER No. 1210 Case only. Dealer's net price \$4.00

No. 1200 VOLT-OHM-MILLIAMMETER. Exclusive Triplett double AC and DC (110V) instrument, readable from any angle. NO TESTER IS MODERN WITHOUT THIS FEATURE. Reads AC and DC up to 1000 volts, 250 mA milliamperes, 3 megohms. Gives output measurements. DC voltmeter has 2000 ohms per volt resistance. Dealer's net price **\$21.67**

No. 1210 TUBE TESTER. GOOD and BAD Scale. Line voltage control. Tests all inter-element shorts. Tests degree of leakages. Provides separate tests for diodes. Easily operated. Dealer's net price **\$20.00**

No. 1220 FREE-POINT TESTER. used with No. 1200 to analyze radio sets. Tests voltages, currents, resistances, capacitance, capacity from point-to-point. Complete with plug socket connections and lead wires. Dealer's net price **\$8.33**

No. 1230 ALL-WAVE SIGNAL GENERATOR Supplies continuously variable signal frequencies from 100 Kc to 18 Megacycles, either modulated or unmodulated. Furnished with batteries and two Type 30 tubes, connecting wires and six graphs on large size charts. Dealer's net price **\$15.33**

THE TRIPLETT ELECTRICAL INSTRUMENT CO.
95 Main St. Bluffton, Ohio, U. S. A.

Write for FREE Literature

The Triplett Electrical Instrument Co.
95 Main St., Bluffton, Ohio

Please send me details on the new Triplett Master Line Radio Testing Instruments.

Name

Address

City..... State.....

Please Say That You Saw It in RADIO-CRAFT

LEADERSHIP in 3 months



is the record of this amazing set

START BUILDING THIS ALL-WAVE SUPER FOR ONLY **\$2.50**

A truly professional receiver, sponsored by 8 leading radio parts manufacturers, that can be built without special tools. Among the features of this now famous set are: band spread over entire tuning range; 7-tube superheterodyne circuit; built-in power pack; all A. C. operation; beat note oscillator; and many others. For only \$2.50 you can secure the ALL-STAR Foundation Kit from your jobber containing drilled Eraydo panel and sub-base, pictorial and schematic wiring diagrams. Then buy the remaining parts as needed. Ask your jobber or write to:

Meissner Mfg. Co., 2815 W. 19th St., Chicago, Ill.	Belden Mfg. Co., 4647 W. Van Buren St., Chicago, Ill.
Thordarson Electric Mfg. Co., 500 W. Huron St., Chicago, Ill.	Ohmrite Mfg. Co., 636 N. Albany Ave., Chicago, Ill.
Cornell-Dubilier Corp., 4377 Bronx Blvd., New York, N. Y.	Crowe Nameplate & Mfg. Co., 1749 Grace St., Chicago, Ill.
Hammarlund Mfg. Co., 424 W. 33rd St., New York, N. Y.	Electrad, Inc., 173 Varick St., New York, N. Y.

FREE—Circuit Diagram and Parts List

Please send me the ALL-STAR Tabloid containing description, diagram, and parts list.

Name

Address

★ CONTINUOUS BAND-SPREAD ★

ALL-STAR

ALL-WAVE Superheterodyne

FREE CIRCUIT DIAGRAM AND PARTS LIST

★ CONTINUOUS BAND-SPREAD ★

ALL-STAR

ALL-WAVE Superheterodyne

We have all parts in stock and can make PROMPT SHIPMENTS. We can supply Kits for any set described in Radio Craft.

Look for important announcement next month on new 1934 Alan P.A. Equipment.

ALAN RADIO CORP.
83-R12 CORTLANDT ST. NEW YORK CITY
Pacific Coast Branch:
1028 South Olive St., Los Angeles, Calif.

FREE CIRCUIT DIAGRAM AND PARTS LIST

★ CONTINUOUS BAND-SPREAD ★

ALL-STAR

ALL-WAVE Superheterodyne

Build the Latest Radio Sensation
We furnish all necessary information How to start, continue and complete the job.
We can make immediate delivery of all parts shown on list.

Radio & Electric Service Co.
N. E. Corner 7th & Arch Sts., Philadelphia, Pa.

(non-resonating—for example, thick wood plates, lead, pure aluminum, etc.). Further, it is necessary to use material with a highly-polished surface. This is the reason why some radio manufacturers use galvanized sheet iron. These diffusion vanes, etc., seemed to be at first very simple, but from the standpoint of acoustics they involve a very complicated system of sound-wave reflections, and a great deal of scientific work will be necessary before the maximum efficiency can be obtained.

Cabinet Acoustics and Low Frequencies

The placement of the speaker close to the floor in the cabinet which houses a high-fidelity receiver chassis has very interesting possibilities. It is known that we can obtain very different sound effects if we move the loudspeaker to various points of the room. The cause of these different effects lies in the multiple reflections, counter-reflections, and sound diffractions that follow the radiation of even a single note! Now we may use (see Fig. 3) the entire room as a kind of reflector, or in other words, as a mixture of a horn and a cone. The floor of the room is one vane, and the back wall behind the cabinet is the other one. Both together have a function which might be compared with the function of a big cone.

It is reasonable to expect that we can produce the best effect if we place the loudspeaker cone just in the center of this giant-cone. That is the reason why we will find in many of the new high-fidelity receivers the loudspeaker practically upon the bottom of the cabinet, or perhaps a few inches above the floor. In some cases the loudspeaker is placed at a certain angle to the back wall to obtain a special reflection "downward" to the floor. And where it is desired to get a second sound diffraction effect it is necessary to place the loudspeaker further from the floor.

Summary

All in all, the design problems of a high-fidelity receiver, while seemingly complex have been, thus far, excellently mastered. Considering that present receivers of this type are comparatively "pioneer" examples of design one must wonder at the amazing efficiency and improved reproduction attained. The salient points in design, which have been outlined, indicate great progress in this direction. What the future radio receiver will sound like can be predicted with assurance, on the basis of present successes in overcoming technical obstacles. Of a certainty the improvements to come will be towards a closer approach of lifelike fidelity in reproduction. The answer to the question, "Is it impossible for you to tell the difference between the original and the reproduction?" will be, absolutely, "Yes!"

A VELOCITY "MIKE" AND PRE-AMPLIFIER

(Continued from page 338)

A Humless Pre-Amplifier
An amplifier which will permit the full benefit of the excellent response of such a microphone must have a useful range between 30 and 12,000 cycles. Such a pre-amplifier, although simple in its operation, presents certain difficulties, particularly if it is A.C. operated. One in which these difficulties have been eliminated is shown in the accompanying photographs, and in Fig. 2.

The simple construction, easy operation, and low cost, puts the described pre-amplifier within the reach of every one. More important, it eliminates the A.C. pre-amplifier's worst enemy—hum. The hum adjuster used is not exactly a hum eliminator, but rather a hum buckler. Yet, unlike a hum buckler, it eliminates background noises but does not introduce any A.C. ripple during the periods of modulation.

It is a well-known fact that one of the primary causes for hum is the source of grid bias. A certain part of the A.C. heater supply, therefore, is introduced into the grid circuit in opposite phase to the existing hum. By merely adjusting the hum buckler, the correct amount of "bucking current" can be introduced.

Automobile tubes have been selected for this pre-amplifier, for two reasons. They offer a minimum level of thermal-agitation noises; and the lower heater current creates a much weaker field around the cathode than tubes of the 2½V. series.

It is needless to say that although the pre-amplifier circuit is a simple one, high grade parts should be used in its construction. The final results cannot be any better than its poorest component. We mean especially all transformers should be so designed that the feeble currents encountered will be passed over the entire audible range. Condensers or resistors should operate quietly. Wire-wound resistors are advisable for the plate coupling units, although there are some high grade carbon resistors that will function as well. The power supply is built on a separate unit to prevent hum pick-up between the input transformer (line-to-grid) of the pre-amplifier and the power supply transformer. The two transformers should be at least four feet apart, although by varying the relative position of one transformer to the other, it is also possible to obtain a minimum pick-up at a smaller distance. The position of the output transformer is not critical. The circuit of the amplifier for A.C. operation is shown in Fig. 2, while a battery operated unit is found in Fig. 3.

In some cases, the "B" supply for the pre-amplifier can be obtained from the main amplifier. If, however, the main power supply is taxed so that modulation causes variations in the "B" voltages, such variation on the pre-amplifier will cause motor-boating. The power "B" supply should only be used for the pre-amplifier when the voltage variations between the conditions for no load to maximum output do not change the "B" voltage by more than 5 per cent. This can readily be checked with a voltmeter.

The gain of the described pre-amplifier is 54 db. when an input transformer of .15-meg. secondary impedance is used. A higher impedance is not advisable since it will tend to drop the response curve on the higher frequencies. However, if the microphone is going to be used on speech only, a complete cut off at 5,000 cycles would not impair the quality of reproduction. In this case, an impedance as high as .25-meg. might be used.

One characteristic of the power supply which must not be overlooked is the use of buffer condensers. Although buffer condensers seem to have gone out of mode with the passing of the gaseous rectifier, their purpose in this case is not exactly to block R.F. currents, but to cut down the peak value of the transformer voltage. You will find that their use will bring down the value of the ripple without further changes in the filter circuit. Another "out-mode" feature, is the introduction of a D.C. potential between the heater and cathode of the amplifier tubes. This is not helpful on the average radio receiver or medium gain amplifier but will give a marked improvement when an overall gain of 120 to 150 db. must be realized in the whole amplifier.

Fig. A. A view of the completed ribbon microphone.



Please Say That You Saw It in RADIO-CRAFT

TOBE EXACT DUPLICATE
ELECTROLYTIC REPLACEMENT CONDENSERS ARE DESIGNED FOR MODERN 1934 SERVICE.

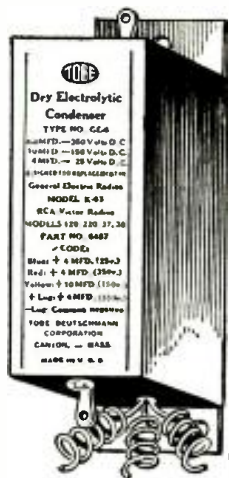

For Neatness, Ease of Installation, High Voltage Safety Factor, Long, Satisfactory Service, Insist Upon **TOBE** Replacement Condensers

Electrolytic condenser blocks like the one illustrated are available for all popular receivers.

Stocked by leading parts jobbers everywhere. Send for latest free condenser bulletins.

Tobe Deutschmann Corporation
CANTON MASSACHUSETTS

It will be noted from the photograph, that a very neat job can be done, inexpensively, by using discarded metal battery boxes (old auto-radio type). Practically any chassis can be adapted and placed inside the box. It can also be noted that the pre-amplifier is placed on top in the rack. The power supply is placed in the bottom to give a maximum distance between input transformer and power transformer, and the main amplifier is placed in the center. Also notice the position of the input transformer.

Two of the dials on the top panel are "ladder" networks for mixing two velocity microphones. The third dial is the 10,000 ohm variable resistor used as a tone control. The lower dial is the gain control of the main amplifier. The meters are employed to check grid—and plate current of the output tubes.

The combination of the ribbon microphone and amplifier shown in the photograph will give straight line amplification over practically the entire audible range, and therefore makes an ideal unit for public address or speech input equipment for low or medium power transmitters.

Hum Bucking

The hum buckler works in the following way. The main source of hum is the grid bias supply which is part of the total "B" supply of the amplifier. Regardless of how efficient the filtering is, it contains a certain amount of ripple.

By connecting a potentiometer across the heater supply, it is possible to introduce a certain amount of alternating current into the grid circuit. The phase and value of this current depends on the relative position of the potentiometer contact arm with reference to the center, which is the neutral point. By careful adjustment of this device, it is possible to buck the ripple almost in its entirety.

Another interesting detail is the introduction of a D.C. potential between the cathode and the heater element. The latter having a positive value. The reason for this is that the heater element like a filament of a vacuum tube will emit electrons. The insulating sleeve between the heater and cathode becomes slightly conductive under the high temperature and, therefore, permits the free passage of electrons towards the cathode. By making the heater positive in relation to the cathode this electronic flow can be reduced to a minimum value.

LATEST TECHNICAL INFORMATION....

YOURS FOR 10c



Now available. A convenient 104-page Manual containing essential information users must have to get optimum performances from any device using vacuum tubes.

Complete data on over 90 receiving tubes. Base Symbols. Recommended Operating conditions, circuit applications, amplifier classifications. Over 150 cuts and diagrams. Represents months of painstaking research by Sylvania's famous technical staff.

This Manual is as necessary as your voltmeter. Just fill in the coupon, attach 10c in stamps and mail.

YOURS! for 10c in STAMPS

HYGRADE SYLVANIA CORPORATION

Makers of SYLVANIA TUBES HYGRADE LAMPS ELECTRONIC PRODUCTS
Factories ST. MARY'S, PA. EMPORIUM, PA. SALEM, MASS. CLIFTON, N. J.
© H. S. Corp., 1934



10c- TECHNICAL MANUAL-10c

Hygrade Sylvania Corporation, Emporium, Pennsylvania. (B-17)
Please send me the new Sylvania Technical Manual. I enclose 10 cents in stamps.

Name
Address
City State

FREE Catalog



180 Pages full of all types of radio and electrical apparatus including: Short-Wave Receivers; All-Wave Receivers; Public Address Systems; Replacement Parts; Tubes; Short-Wave Products and thousands of items too numerous to mention.

The greatest radio catalog for the general radio trade. **GUARANTEED LOWEST PRICES—GUARANTEED QUALITY.** Send For Your Free Copy TODAY!

An All Around Radiobook

A general book covering every factor in radio including Short-Waves, All-Waves, Public Address and Transmitting. Hundreds of illustrations and schematics. Every article is a "how-to" for the low price every radio man—service man, dealer or experimenter—can find this book an indispensable asset to his radio library. Bound in Cardinal Red Leatherette Cover. Send For Your Copy Today!



TRY-MO RADIO CO.
85-C Cortlandt St. New York, N.Y.

POSTAL PRESENTS The GREAT 35 ALL-WAVE
USED BY CAPT. MORACE L. HILL
Over 50 important features such as new drawer type coils—large calibrated aerophone dial—triple tracked continuous bandspread—A. V. C. with two dual volume controls—resonance tuned Radio Frequency Stage—electron coupled oscillator—audio beat oscillator—precision tuning meter and many other features to make the POSTAL 35 one of the finest sets yet built. All-wave receivers. WRITE IMMEDIATELY FOR FREE DESCRIPTIVE PAMPHLET NO. 150 AND SPECIAL PRICES TO RADIO-CRAFT READERS.
POSTAL RADIO
135-K LIBERTY ST. NEW YORK, N.Y.

RADIO MEN!
On page 372 of this issue will be found complete details about the finest SCIENTIFIC—MECHANICAL—CONSTRUCTIONAL magazine in the field. This magazine is EVERYDAY SCIENCE AND MECHANICS... now on all newsstands at 10c a copy.

PEE-WEE ANALYZER

(Continued from page 350)

a 7-prong plug for which adapters must be obtained so that receiver analyses may be made into 4-, 5-, and 6-prong receiver sockets. The numbers below the bottom row of jack openings indicate connection to a corresponding pin number to the socket terminal, in accordance with RMA specifications (recently adopted). Thus quick and simple access to any desired terminal position of a socket is thereby possible.

The small flashlight battery for resistance tests is enclosed within the case. By simply throwing the toggle switch to the "Ohms" position, all resistance tests of an average order are possible. The small knob in the center of the panel is for obtaining zero adjustment on the ohmmeter scale when the two test leads are shorted.

Lists of Parts

One Weston model 301 universal A.C.-D.C. meter (0-1 ma.). Has four terminals: 0-5 V. A.C. and 0-1 ma.:

Fig. 2
Meter circuit for A.C. readings.

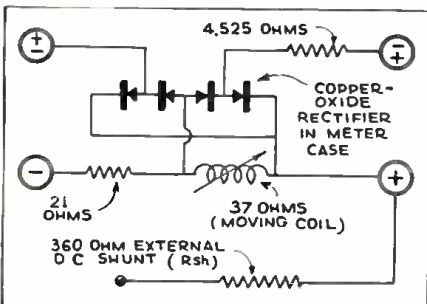

Please Say That You Saw It in RADIO-CRAFT

HOW TO BUILD, TEST AND REPAIR RADIO SETS



Radio Construction Library

Including Television, Short-Wave Receivers and Auto Radios. 3 Volumes. 5 1/2x8—1177 pages, 561 illustrations

This practical library includes: PRACTICAL RADIO—The fundamental principles of radio, presented in an understandable manner. Illustrated with working diagrams. PRACTICAL RADIO CONSTRUCTION AND REPAIR—Methods of locating trouble and reception faults and making workmanlike repairs. Discusses modern short-wave receivers and installation of automobile radios fully. RADIO RECEIVING TUBES—Principles underlying the operation of all vacuum tubes and their use in reception, remote control and precision measurements.

Helps you to understand modern type receiving sets—full of construction data and practical hints for the experimenter.

10 Days' Free Examination Easy Terms

McGraw-Hill FREE EXAMINATION COUPON

McGraw-Hill Book Company, Inc. 330 W. 42nd St., New York. Gentlemen—Send me the RADIO CONSTRUCTION LIBRARY, all charges prepaid, for 10 days' Free Examination. If satisfactory I will send \$1.50 in 10 days, and \$2.00 a month until \$7.50 has been paid. If not wanted I will return the books postpaid.

Name.....
Home Address.....
City and State.....
Position.....
Name of Company..... RC-12-34

TOBE UNIVERSAL ALL-WAVE ANTENNA SYSTEMS

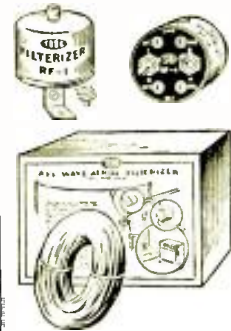

Designed by pioneer specialists in RADIO NOISE ELIMINATION

OUTSTANDING FEATURES:

1. Adapted to simple inverted "L" flat tops and to single or multiple half-wave doublets.
2. Wave band switches tune antenna system to listening band, assuring maximum signal strength.
3. Ample noise reduction.
4. Rugged weather-proof materials.
5. Two models—\$4.95 and \$6.95.

Stocked by leading parts jobbers everywhere.

Send for latest free bulletin.

Tobe Deutschmann Corporation
CANTON, MASSACHUSETTS

- *Two black phone-tip jacks;
- *Fourteen 101JR red phone-tip jacks;
- *Two red side-pressure jacks;
- *Six No. 102JR red circuit-opening jacks;
- *One No. 456 silver contact composite socket;
- *One No. 477 composite socket;
- *One No. 907 WLCAP kit;
- *One No. 111 DLT current plug lead;
- *One No. 112 SLT jumper lead (black);
- *One No. 112 SLT jumper lead (red);
- *One S.P.D.T. toggle switch with center "off" position;
- One D.P.D.T. toggle switch;
- One 1000 ohm midgeet rheostat (ohmmeter adjuster);
- One fountain pen 4.5 V. flashlight battery (3 cells);
- One each, Weston multipliers, 4,950 ohms, 5,000 ohms, 40,000 ohms, 50,000 ohms, 400,000 ohms, and 500,000 ohms;
- One each, ohmmeter resistors, 10 ohms, 35.1 ohms, 910 ohms and 4114.9 ohms;
- One each, series shunt resistors, .744 ohm, 6.696 ohms, 66.96 ohms and 297.6 ohms;
- *One molded case, 5x6 1/2 x 2 ins.;
- One 5x6 1/2 ins. engraved panel;
- Miscellaneous screws, wire, solder, etc.

*Name of manufacturer supplied upon request.

A UNIVERSAL-CURRENT ARM-REST PORTABLE

(Continued from page 337)

ing its frame to accommodate the drum dial, we fasten the unit in place using 8/32 machine screws with a 1 inch metal washer and a 1 inch sponge rubber washer on each side of the chassis pan. This results in a three point shock-proof mounting which is quite necessary under the circumstances to eliminate acoustic feedback.

Should the constructor desire to use a gang condenser other than the one specified, it must be observed that any discrepancy in physical dimensions will result in failure of the knobs to attain the proper location in the case, unless provision is made accordingly. A condenser of lighter construction is also likely to cause trouble from acoustic feedback.

The shielded coils are fastened to their respective brackets: the antenna coil to bracket J in Fig. 2 and the interstage coil to bracket K. The same bolt which holds the coil in its shield holds the assembly to the bracket. Together, with their associated dual bypass condensers, they are fastened to the chassis by means of the same bolts which carry the R.F. and converter tube sockets. This detail is shown in Fig. 3 in which the antenna coil is represented at A and the R.F. coil at B.

The oscillator assembly is next in order. It will be noted that the oscillator coil is mounted upon the tracking condenser, the same two 6/32 machine screws which pass through the chassis pan and shield can serving to bind the whole unit together. Fiber or lock washers should be placed on both sides of the tracking condenser to prevent the isolantite base from becoming cracked through torsional strains.

While it is rather difficult to home-construct the antenna and R.F. coils because of their miniature size and universal windings, the experimenter may easily wind the oscillator coil should he choose to do so. Accordingly, winding data is given under Fig. 3. The plate coil is wound in the direction opposite to the grid coil. The low end of the grid coil is fastened directly to the mounting strip and the other three leads fastened to lugs. Tracking adjustments are obtained in the usual way.

The first I.F. transformer is a double-tuned assembly of conventional style, but the second unit is very closely coupled and may therefore be only single-tuned. In selecting coils for this assembly, units of large physical dimensions should be chosen, or a single unit transformer in which both coils are wound together. A half-wave circuit is employed in preference to full-wave because a higher rectified voltage is thus obtained.

Condensers C1 and C2 are mounted to the chassis pan under the R.F. tube by means of a metal strap. Condensers C3, C4, and C5 are mounted on the opposite side of the pan with a similar strap, and each condenser case is bonded to its retaining strap with solder. The grounded sides of the condensers are not connected to these straps but are connected to the

The MATTHEWS' Challenger!

As featured in November Radio-Craft
NOISE-FREE RECEPTION WITH THE NEW
FREQUENCY CONVERTER
An Exclusive Feature in this NEW All-Wave Receiver

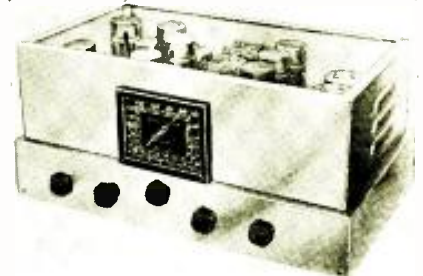

CUSTOM BUILT TO YOUR REQUIREMENTS

- All Wave 13 to 560 Meters. • Fourteen Latest Type Tubes. • New Frequency Converter Stage. • No Noise. • Ten Kilocycle Selectivity. • Four Gang Condenser. • Twenty-Pound Dynamic Speaker. • Eighteen Watts Output. • Chromium Plated Chassis. • Modernistic Airplane Dial with Owner's Name Included.

Write for Prices and Complete Descriptive Literature

MATTHEWS RADIO 22-14 40th Ave. Long Island City, N. Y.

EUROPEAN RECEPTION GUARANTEED

You either listen to Europe or—we refund your money. Two band—short wave and broadcast; excels many large radios. Amazing distance, loads of volume and fine tone—all complete—no extras.

AGENTS WANTED—BIG PROFITS—EASY SALES

Sell radios you can guarantee. Save big profits—buy direct from factory with 14 years' experience—no guess work, the only line of radios sold exclusively through radio service men. All sizes but only one quality—never built down to a price, but by dealing direct your costs are low—profits large.

EXCLUSIVE FRANCHISE TO RIGHT MEN

We want one man each town and one only. Our line is complete—5, 6, 7, 10, and 12 tubes AC, also 5, 7, and 9 tube battery operated; 32 volt, also auto radio. Send for beautiful photographic reproductions to show customers—they are FREE to all radio service men. Write today.

F. A. WILCOX, 308 W. Randolph St., Chicago, Ill.

AGENTS WANTED!
MOTION PICTURE SOUND
Most fascinating field awaits live Radio Service Men—quick, sure profits
ASK FOR FREE CATALOGS
S.O.S. CORPORATION
1600 Broadway New York, N. Y.
Cable Address: "Sosound" New York

Leotone has it!
Try LEOTONE for all radio replacement needs. Jobbers, Mail Order Houses and Representatives in all territories—there are two very fast movers.
Free Edge Cone and Voice And-Field Coils for all Coil Assemblies Dynamic Speakers
We also Manufacture Various Types of Magnetic Speakers
We Can Supply and Remedy Your Speaker Needs. *Speaker Mfg. Since 1921*
LEOTONE RADIO COMPANY
63 Dey Street New York, N. Y.

1935 RADIO CATALOG *Free Book*
All models: AC-DC midgeets: dual and world-wide all-wave ferris, battery and car—at factory prices! Write for 24-page Bargain Catalog and 30-DAY TRIAL plan. Prices from \$9.95 UP. **AGENTS WRITE!**
GOLDENTONE RADIO CO.,
112 Oakman Bldg., Detroit, Mich.

THE ALL-ELECTRIC ALL-WAVE RECEIVER
A completely electrified SW receiver capable of world-wide reception. Uses special circuit for resulting in 4 tube performance. Operates entirely on 110 volt ac or dc house lighting system. 4 tubes for 10-200 meters and instructions included.
Foreign Reception Guaranteed.
R.F. \$5.95 Wired, extra..... \$1.35
Broadcast coils \$0.95 Arcetux tubes..... 2.20
C.O.D. ORDERS FILLED. PROMPT SHIPMENT
EILEEN RADIO LABS., Dept. RC12
463 Fourth Ave. New York, N. Y.

Please Say That You Saw It in RADIO-CRAFT

chassis pan directly with short lengths of wire. The choice of can type condensers in these particular locations is based on a desire for rigidity, since they provide good solid lugs with which to anchor their associated resistors.

The bakelite strip shown at G in Fig. 2 is supplied with soldering lugs for each hole, the three center ones being made fast with machine screws into the threaded bakelite and the other two with the screws which hold the strip in place. Spacing washers are employed to maintain 1/2-in. clearance between the strip and the pan. Note that all screws coming through the outside of the pan must be flat-head screws and properly countersunk since we intend to fit the carrying case snugly around these surfaces.

Lugs are also fastened to bakelite strip F in Fig. 2, leaving the holes which are not tapped to fasten the whole strip to the speaker frame by means of D and E (Fig. 2). The bracket which originally carried the output transformer now carries this assembly.

The filter condensers are potted in a tin box whose dimensions are given at L and M in Fig. 2. Four individual units comprise the assembly, and they are wired together and the lead wires color coded before the sealing compound is poured into the can. The colors are given in the schematic, Fig. 1. The other parts may be mounted and wired without regard to any particular order.

The Power Supply

Where a radio set employing a mechanical inverter is permanently installed in an automobile, it is generally deemed unnecessary to fret about battery polarity since the installation once correctly made need not be disturbed, but in an outfit which is to be moved in and out and perhaps from one car to another some provision must be made to meet varying conditions. A polarized relay might be used, of course, but the arrangement employed here is simple, more positive, and less expensive. It consists of an automobile ammeter and a six prong plug with a reversible socket. An ordinary socket may be used by reaming one hole adjacent to the heater prongs to the larger size so that the plug may be inserted in two positions. An arrow is inscribed on the outside of this plug. The method of operation is simple: The set is connected to the power with the polarity plug removed. When the power switch (on the volume control) is turned "on" the ammeter needle jumps to right or left—we simply insert the plug with its arrow indicating the same direction and connections are properly made. The proper direction to connect the meter is readily determined by experiment since it may involve only a single permutation.

It might be well to observe at this point that the polarity plug we have just mentioned is also used to change from A.C. to D.C. operation by inserting it in the proper socket.

The adapter to accommodate the set to 220 volts is simply one of the old ventilated "voltage regulators" which were intended to be inserted between the power cord and the wall outlet. The original resistor unit is removed and a wire-wound porcelain unit of the proper value is inserted in its place.

To insure an absence of vibrator hash, certain precautions must be observed. The moving arm in the vibrator unit must be grounded to the chassis immediately at the socket. Both R.F.C.1 and R.F.C.2 must be individually shielded. It is important that they be located at the point where the transformer leads come through the chassis. Condensers C26 and C27 are .001-mf. units and are contained within the vibrator.

Fig. E

"Opened up" view of arm-rest portable.

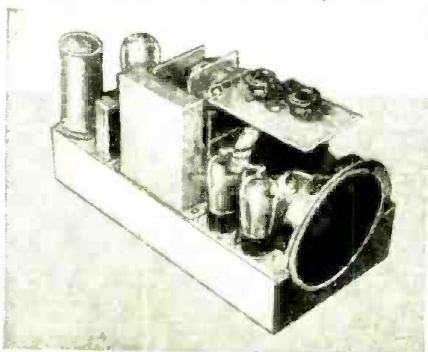

FREE The BIGGEST Latest, Most Complete 1935 RADIO CATALOG



This amazing new 1935 Radio Catalog is the last word... the greatest Bargain Book of Radio ever published. There are more pages, more items listed, more nationally known lines, more Specialized Departments. Over 50,000 items make this great 192-page book the Sensation of the Radio Industry!

There is a Special Department on the latest Broadcast and All-Wave Receivers from 2 to 12 tubes. You'll find an entirely new Department on REFRIGERATION PARTS AND ACCESSORIES... a new money making field for Servicemen. A whole section on PUBLIC ADDRESS is the most complete and all inclusive thing of its kind.

Then there is our matchless SPECIALIZED SHORT WAVE DEPARTMENT which constitutes a complete catalog listing everything the Ham, Brasspounder and Experimenter will ever need; Sets, Kits, Transceivers, Pre-Selectors, Converters, 5 meter Equipment as well as other Short Wave parts and accessories. For 13 years the "WHOLESALE" Catalog has been the Serviceman's "Bible." Today—this greatest Radio Catalog ever printed in which everything is listed at lowest wholesale prices—is yours for the asking. Write today for your FREE copy!

BUILD YOUR OWN 5-Tube AC-DC Super-het Receiver Kit

All you need is a screw driver, pliers and soldering iron to build this new Trutest 5 tube AC-DC Super-het! Although small in size, it is a full grown super-heterodyne with a pre-selector stage ahead of the first detector. Chassis measures only 10 1/2" x 4 1/2" x 6 1/2" high. Features include 5" dynamic speaker, 3 gang tuning condenser with illuminated dial, smooth action volume con-

trol, etc. Wave length range 190-550 meters. Comes completely drilled. No extras to buy except tubes. Simple to build from our detailed, easy-to-follow diagram and wiring instructions. No. Y 22014—5 Tube AC-DC Kit, \$12.95 including speaker but less tubes. \$3.20 Matched kit of tubes.



Wholesale Radio Service Company
100 Sixth Avenue, Dept. C-124
New York, N.Y.

Send me your new 1935 Catalog No. 56.
 Send me the order I have described in attached letter.

Name _____
Address _____
City _____ State _____

WHOLESALE RADIO SERVICE CO. INC.

NEW YORK ATLANTA
100 Sixth Avenue 430 W. Peachtree St., N.W.
Local Branch 219 Central Ave., Newark, New Jersey.



FOX EQUIPPED!

When Fox equipped, it means dependability with full frequency response at a minimum Power Input. Insures full Coverage at a lower cost.

FOX SOUND EQUIPMENT CORP.

Manufacturers of Fox Sound Products
3120 Monroe Street Toledo, Ohio



Write for our latest catalogue.

YOUR LAST OPPORTUNITY!

The 1935 OFFICIAL RADIO SERVICE MANUAL will be off press shortly. In order to make certain that you get your copy at a special saving, be sure to read the announcement which appears on page 324 of this issue.

Please Say That You Saw It in RADIO-CRAFT

Freed-Eisemann
FAMOUS SINCE BROADCASTING
BEGAN
ALL WAVE RADIO



Model 482 (above) 8-tube A.C. All Wave Super-heterodyne. Tunes from 11-500 meters (21,500-540 K.C.) in 4 tuning bands. Dial printed in colors to show different types of broadcasting.

Model 366 (below) 6-tube A.C. All Wave Super-heterodyne compact type; illuminated dial; tunes all stations from 14-500 meters (21,500-540 K.C.) in 4 tuning bands.



Special discount for dealers, service men, amateurs and engineers. Write for full details and prices of these sets, large All Wave chassis and other models. Special expert sets available for 220 volts; also 200-550 and 900-2000 meters.

FREED
TELEVISION AND RADIO CORPORATION
LONG ISLAND CITY, N. Y. U.S.A.



What OTHERS say is What COUNTS!

The expressions we get from others mean more than anything we can say about the

WRIGHT-DE COSTER Speaker

Read this letter from Mr. Percy Harris, Washington, D.C.—“I received the Model 265 speaker September 8th and am very much satisfied with the speaker in every way. The tone is truly wonderful, the high tones are brilliant and clear and all of the low tones are brought out, deep and mellow; speech is distinct. The Model 265 speaker puts my radio in a class by itself.”

If the reproduction in your radio is not satisfactory, we know that it can be greatly improved by the installation of a Wright-DeCoster Speaker.

Write for further particulars,
WRIGHT-DE COSTER, Inc.
2251 University Avenue, St. Paul, Minn.
Export Dept. M. Simons & Son Company,
25 Warren Street, New York
Cable Address: Simonrice, New York

Units C22 and C23 should be located within the transformer shield, and C24 and C25 should be located as closely as possible to the vibrator assembly. Other matters of importance in auto installations have been discussed at great length in previous issues of this magazine and scarcely need repeating.

Fir plywood, 1/4-in. thick is the principal material for our carrying case. Ample strength is assured by covering it with imitation leather, gluing corner blocks in the joints around the top, and screwing brass corner plates to the finished case. The handle may be detached in an instant and contained within the case if the set is to be used in one location for an appreciable length of time. Details of the hooks as well as the dimensions of the case are given in Fig. 3. By opening the door over the connection plate, access is gained to a space sufficient to contain all the power cords, adapters and the carrying handle, albeit, under ordinary conditions, the 6 volt cable will be left connected to the car in which the set is generally used. This door is cut with a thin saw after the case is completed. Stops are then glued on the inside of the box and a spring catch used to hold the door shut. Small hinges are tacked on the bottom. The hole which was bored to insert the saw is large enough so that one may insert a finger in order to open the door.

On the under side of the top, at the speaker end, a piece of 1/2-in. wood approximately 6 1/2 x 7 1/2 inches is snugly fitted and glued in place. An opening for the control knobs is made with a saw held at an angle so that the hole is about a half-inch smaller in each direction at the bottom. A layer or two of felt is glued to the under side so that the dial plate fits snugly when the chassis is placed in the case. See the photograph (Fig. A).

The ultimate appearance of the chassis is shown in Fig. E. In this picture the bottom plates have been removed, but it will be seen that they fit within the sides of the case and are made fast to the flanges on the bottom of the chassis pan by means of 8/32 flat-head screws. The first plate is simply a sheet of tin for electrical shielding. It is held in place by the other which is made of 1/4-in. plywood. When both are in position they are flush with the bottom of the case. The holes which are used to hold the chassis in the case are not indicated on the drawing in Fig. 2 because the builder will be able to locate them more accurately by marking through the holes in the case with the chassis in place. Flat-head 8/32 machine screws with washers and nuts are used here.

If the parts above the chassis pan are thoroughly shielded, no difficulty will be encountered from surrounding interference. The detector and output tubes need not be shielded.

The following points are of a more or less general nature, and are applicable to any amateur construction; an examination of a few home-built sets will convince anyone that they are only too seldom observed.

First of all, if every part were to be tested before it went into the set, the battle would be

half won! The value of every resistor should always be checked; every condenser should be examined for leaks especially those in A.V.C. circuits and those used to couple audio circuits to a pentode grid. They should be completely non-conductive so far as one can determine with ordinary service instruments. A gang condenser which has been in an experimenter's workshop for some time is very likely to have a plate or two sprung or a high-resistance leak on one of the insulating strips. Such conditions often result in much cogitation and head-scratching when the constructor observes noise and poor A.V.C. action in the finished set. Other parts should be given at least routine tests for continuity and short-circuits.

Secondly, the whole job should be made absolutely rigid. The builder should aim to construct a chassis of such rigidity that it might withstand the famous fountain pen test of being dropped from a great height. This may appear to be undue emphasis, but it concerns the weakest point in the amateur's usual job, and it is a matter of paramount importance in the building of a portable receiver.

Additional Wiring Hints

More yet might be said with regard to wiring practices. Where a pigtail condenser or resistor is to be connected to a wire or another pigtail, it is not enough to solder the two together and let them hang; a rigid lug should be provided and both members soldered thereto. If the entire length of pigtail is utilized, rubber or cambric should be slipped over the greater portion of it leaving bare only sufficient wire to provide for the connection. The careless mechanic holds a wire in place and drops a bit of solder on it. This does not constitute a good connection; the wire should first be made fast mechanically and the solder applied to insure electrical contact. High-voltage circuits should always be wired with heavily-insulated wire, and rubber-covered wire rather than pushback should be utilized in A.V.C. circuits.

Although the A.V.C. system has been designed to cover a wide range of signal inputs, a problem naturally arises in a set of this type due to the wide variety of antennas with which it may be required to operate in different locations. An automobile antenna which provides miserably small pickup may be employed one day, and the next day we may bring the set into the house and hook it to a huge, inverted L—and perhaps our local station is a few blocks away! Those designers who have not ignored the problem generally use a “local-distance” switch or a “sensitivity control” with good results, but it will be found quite as satisfactory to design for minimum pickup and when difficulty is encountered with a large antenna to simply wind a few turns of the antenna lead around the insulated lead from the set instead of connecting it directly. This is our plan in the present instance.

List of Parts

Four Cornell-Dubilier can type condensers, .1-mf., 200 V., C1, C2, C4, C5;

Fig. 3
Details of case, coil, and essential circuit-changing plugs.

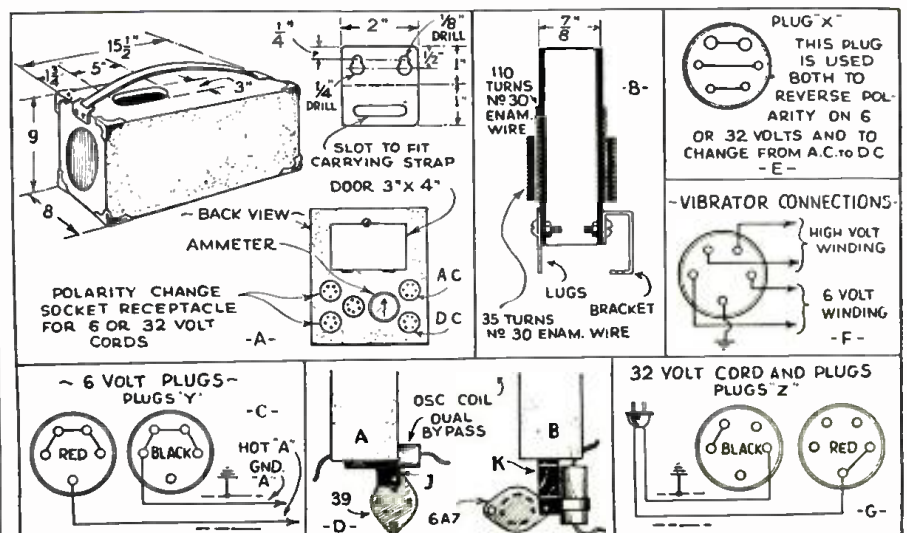

Please Say That You Saw It in RADIO-CRAFT

THE MODEL 22 TUBE TESTER



The greatest value possible for the money. Beautiful quartered oak case, veri-chrome lettered bakelite panel, 3/4" D'Arsonval type meter 2% accuracy. Tests all present-day tubes with ample provisions for the future types. Neon leakage and short test of all tube elements. Direct reading. Provisions for resistance and condenser test.

\$23.75

WRITE FOR CIRCULAR ON OUR NEW COMBINATION UNIT. Tube tester and volt-ohm-meter. A complete electrical-radio service outfit in one unit. \$34.90.

A.C. D.C. METER 0-1 MIL-AMP. \$4.90.
ALL TYPES and kinds of ROTARY SWITCHES. Our new bulletins describe all the above units. Mailed on request.

L & L ELECTRIC COMPANY
336 MADISON AVE. Dept. 14-A MEMPHIS, TENN.

FREE !! WESTON EQUIPMENT

The facts are: 1—A CHUCKER is a compiled, cross-indexed radio trouble-graph and repair-pricer, which eliminates guesswork. 2—The trouble-graph feature enables you to isolate any fault in any radio, quickly, right in the field. 3—The repair-pricer feature publishes a professional fee for each job, based upon a \$1.50 hourly labor rate plus list-priced parts, which you can quote at once. 4—A CHUCKER inspires set-owner confidence by distinguishing between guesswork-mechanics and Professional service men.

Now then—every plumber's helper and his brother are exploiting radio service as a spare time football. They have caused a question to arise of VITAL IMPORTANCE to the success of every progressive radio man. Your future is at stake!

To encourage you to answer this vital question, we will AWARD WESTON testing EQUIPMENT FREE, for the best brief answer! Your copy of the vital question is free. Radio CHUCKER is \$1.00 postpaid. Send for either or both NOW!

FREED'S RADIO CO.

Publishing Division R
5053 Baltimore Ave. Philadelphia, Pa.

SERVICEMEN! STEP AHEAD of the rank and file—



with "CASE RECORDS OF BROADCAST RECEIVER REPAIRS"

- ADD 10,000 Hours to your experience!
- ELIMINATE GUESSWORK IN YOUR SERVICING!
- DON'T PUZZLE YOUR PROFITS AWAY!

\$4.75

Your work is already done and recorded for you in "CASE RECORDS." This 9x12" loose leaf binder contains 1,500 alphabetically and numerically arranged "CASE RECORDS" of SUCCESSFULLY COMPLETED SERVICE JOBS! Each "CASE RECORD" tells all details for satisfactory repair. SUPPLEMENTED QUARTERLY FREE for 1 year. 108 receiver make-ups. 3,000 models.

... the FASTEST Technique known to the Profession!
Send Only \$1.00 Deposit for Ten-Day Inspection... No Obligation
Immediate refund on return of Manual
CAPITOL RADIO RESEARCH LABORATORIES, INC.
1503 21st St., N. W., Washington, D. C.
H. K. Bradford, President and Technical Director

MICROPHONES and ACCESSORIES
Unexcelled for Performance, Utility and Economy!
At Your Jobber
SHURE BROTHERS COMPANY
Microphone Headquarters
215 W. HURON ST., CHICAGO, U.S.A.

- One Cornell-Dubilier can type condenser, .5-mf., 100 V., C3;
- Two Cornell-Dubilier dual tubular condensers, .1-mf., 200 V.; C6-C7, C8-C9;
- One Cornell-Dubilier variable padding condenser, .0075-mf., C29;
- Four Cornell-Dubilier mica condensers, 250-mmf., C10, C11, C12, C13;
- Two Cornell-Dubilier paper condensers, .03-mf., 400 V., C15, C28;
- One Cornell-Dubilier mica condenser, .001-mf., C14;
- One Cornell-Dubilier dry electrolytic condenser, 10 mf., 25 V., C16;
- One Cornell-Dubilier dry electrolytic condenser, 4 mf., 200 V., C18;
- One Cornell-Dubilier dry electrolytic condenser, 8 mf., 450 V., C19;
- Two Cornell-Dubilier dry electrolytic condensers, 24 mf., 200 V., C20, C21;
- Two Cornell-Dubilier condensers, .001-mf. contained within vibrator case, C26, C27;
- Three Cornell-Dubilier condensers, .5-mf., 100 V., C23, C24, C25;
- One Cornell-Dubilier condenser, .5-mf., 400 V., C22;
- One Cornell-Dubilier mica condenser, .006, C17;
- One Cornell-Dubilier paper condenser, .1-mf., 200 V., C30;
- One IRC carbon resistor, 400 ohms, 1/4-W., R1;
- One IRC carbon resistor, 150,000 ohms, 1/4-W., R2;
- Two IRC carbon resistors, 50,000 ohms, 1/4-W., R3, R13;
- One IRC carbon resistor, 150 ohms, 1/4-W., R4;
- Two IRC carbon resistors, 20,000 ohms, 1/4-W., R5, R11;
- One IRC carbon resistor, 4,000 ohms, 1/4-W., R6;
- Three IRC carbon resistors, 500,000 ohms, 1/4-W., R7, R8, R15;
- One IRC carbon resistor, 30,000 ohms, 1/4-W., R9;
- One IRC carbon resistor, 200,000 ohms, 1/4-W., R10;
- One Electrad volume control with switch, 0.25-meg., R12;
- One IRC carbon resistor, 0.25-meg., 1/2-W., R14;
- One IRC carbon resistor, 1000 ohms, 2 W., R16;
- One Electrad wire-wound resistor, 12 ohms, 75 W., R17;
- One Electrad wire-wound resistor, 140 ohms, 25 W., R18;
- One IRC carbon resistor, 40 ohms, 2 W., R19;
- One "Resistovolt" or similar device for 200 V. adaptor;
- One IRC porcelain resistor for same, 320 ohms, 30 W.;
- One heavy cast frame 3 gang condenser;
- One GenRal midjet shielded antenna coil, L1;
- One GenRal midjet shielded R.F. coil, L2;
- One GenRal oscillator coil and shield, L3;
- One GenRal double-tuned I.F. transformer, 175 kc., I.F.T.1;
- One GenRal single-tuned close-coupled I.F. transformer, I.F.T.2;
- One Wright-DeCoster 6 in. dynamic speaker;
- One composition drum dial;
- One General Transformer vibrator-inverter unit, type 60;
- One General Transformer power transformer, for 230 V., at 40 ma.;
- One General Transformer R.F. choke to carry "A" current, R.F.C.1;
- One Hammerlund R.F. choke to carry "B" current (85 mh.), R.F.C.2;
- Five 6 prong sockets, 1 1/2 in. mounting centers;
- Five 5 prong sockets, 1 1/2 in. mounting centers;
- One 4 prong socket, 1 1/2 in. mounting center;
- One General Transformer filter choke to carry 50 ma., 20 hy., Ch.1;
- Two pilot light sockets;
- Two pilot lights, 6.3 V., .15-amp.;
- Four Na-Ald 5 prong plugs;
- One Na-Ald 6 prong plug;
- Two tube shields;
- No. 24 enameled wire, 1/2 lb.;
- Carrying case, as described;
- Five control-grid clips;
- One Sylvania type 25Z5 tube;
- One Sylvania type 12Z3 tube;
- One Sylvania type 38 tube;
- One Sylvania type 75 tube;
- One Sylvania type 6A7 tube;
- Two Sylvania type 39 tubes;
- One automobile ammeter;
- Sheet steel and tin, screws, nuts, washers, hookup wire, brass corners, fine wire screen, etc.



How Good is YOUR Tube Tester

Make this test and judge for yourself

Remember how we have emphasized the fact that more tubes require replacement because of noisy reception resulting from internal leakages than for any other reason? And how Supreme Neonized Tube Tester Model 85, has proved this, when other tube testers gave the tubes an O.K.?

Now make this test and judge for yourself. Take a power tube, a type 45, 2A5, 71A, etc. Be sure that the tube is a good tube. Then—close to the base—solder a 100,000 Ohm resistor between the plate and control grid. Substitute this tube for a tube in a radio known to be operating at its peak of efficiency. NOTICE THE DISTORTION—THE NOISY AND UNSATISFACTORY RECEPTION—AND OFTEN, THE COMPLETE SILENCING OF THE RADIO.

Now that you know you have a tube unfit for use or entirely unsatisfactory and, in fact, now that you know you have a tube in the same condition as a great many other tubes in the possession of many of your customers, place this same tube in YOUR tube tester, and observe the result. 95 times out of 100, the tube will test "GOOD". Convincing evidence that you are losing more than 50% of the tube business you should have... simply because of inadequate and out of date methods.

Now test this tube on a SUPREME NEONIZED TUBE TESTER 85. Your jobber will gladly make it available to you. Notice how the Neon signal immediately flashes the elements between which the leakage or short is occurring, and proves to anyone that satisfactory reception is impossible with such a faulty tube. This super tube tester will pay for itself and the out-of-date tube-tester it replaces, in short order.

SUPREME NEONIZED TUBE TESTER 85-P

Dealers Net Cash Wholesale Price

Available also in modernistic Walnut upright Counter Model. **\$39.95**

SUPREME INSTRUMENTS CORP.
509 Supreme Bldg., Greenwood, Miss.
Please send complete detailed Catalog 1935 Supreme Models.

Name

Address

City State

Jobber Preference.....

Please Say That You Saw It in RADIO-CRAFT



Mr. E. H. Rietzke, President of CREI and originator of the first thorough course in Practical Radio Engineering.

Mr. Service Man . . .
IF YOU'RE "SOLD" ON STUDYING
. . . WHY NOT TAKE THE BEST?

Although CREI is a nationally accredited school, known and recommended throughout the industry, it is not "out of reach" of any service man! Our home study courses in Practical Radio Engineering are written in "service man" language, and are practical right from the beginning. After the first few lessons, you can start capitalizing on the information you have learned . . . but you'll see real results after you have finished the thorough technical training CREI offers. Terms may be arranged to meet your own needs.

Now Offered for the First Time!
AUDIO & ACOUSTICAL
ENGINEERING

A new series of lessons now included as a part of all courses. These new lessons will prepare the engineer to handle practical problems arising in the design and installation of audio and acoustical systems.

WRITE TODAY—OUR NEW 44 PAGE
CATALOG IS JUST OFF THE PRESS

Send for this new booklet today. It gives in complete detail everything you'll want to know about CREI, together with scores of pictures, of our school and array of equipment.



CAPITOL RADIO ENGINEERING
INSTITUTE

14th and Park Road, Washington, D. C.
Dept. RC-12

The **TOBE** CONDENSER
ANALYZER
actually "X-Rays"
Condensers . .

Look into the "heart" of the condensers you buy before using them. Test all condensers in the receivers you service before putting your O. K. on the job.



The TOBE CONDENSER ANALYZER instantly indicates if condensers of any type—paper, mica, oil, electrolytic—of any capacity from .00005 to 100 mfd.—are of low D. C. resistance or high current leakage and will soon break down or become "open"; are operating intermittently (loose internal connections) or if they are "open" or "shorted."

Thousands of servicemen are now using this instrument.

110 volt, 60 cycle Model
\$11.40 NET

Available in 25 cycle, and 220 volt Models. . .
Stocked by leading parts jobbers everywhere.
Send for latest free literature.

Tobe Deutschmann Corporation
CANTON, MASSACHUSETTS

THE LISTENING POST
FOR ALL-WAVE DX-ERS

(Continued from page 351)

sselede, Belgium, is on 29.04 meters (10,330 kc.) almost every day between 1:45 and 3 P. M., E.S.T. Their antenna is beamed on the Belgian Congo and he puts in a good signal. Station OA4K is on about 38.5 meters from about 9 to 9:30 P. M., E.S.T., but code QRM tears him up terrific. For 16 mornings straight Mr. Tomlinson tuned in J.V.M. Nasaki, Japan, 27.93 meters (10,740 kc.), and he came in best early in the mornings, signing off at 7:40 A. M., E.S.T. Station JVN, Nasaki, Japan, on 28.14 meters (10,660 kc.) was logged at 10 P. M., E.S.T., working with KWU, Dixon, Calif. Station JVF, Nasaki, Japan, on 19.20 meters (15,620 kc.) was heard calling KWU at 9:30 P. M., E.S.T. One morning, recently, Mr. Tomlinson was able to tune in FZR, Saigon, French Indo-China on 18.5 meters, (16,230 kc.), rag chewing with FTK in France. He managed to hold them for about 25 minutes.

Mr. John Shanks, of Russellville, Tenn., says, "I believe the mystery station on 44.71 meters (6,710 kc.), that announces "La Voz de los Tropics" from about 8 to 9:30 P. M., E.S.T., is located in San Jose, Costa Rica. (You are right, Mr. Shanks, and further, the call of this station is TIEP.—Editor.)

One of the greatest thrills on the short waves today is to tune-in Bob Bartlett's schooner "Effe Morrissey" bound for Arctic regions. The call used is W10XDA, and he uses 100 watts. Station W10XDA is usually located about the center of the 20 meter ham band. John DeMyer of Lansing, Mich., heard him at 6:00 P. M., E.S.T. Frank Hostetter, of Dillonvale, Ohio, also reports W10XDA. Your editor heard him recently at 6:40 P. M., C.S.T., broadcasting from Hopedale, Labrador. He had brought about 50 Eskimos to the microphone from the nearby Moravian Mission, and their husky voices singing those old-time church tunes sure produced a weird effect.

An official letter from Sr. Luis Ramirez Arana, Jefe del Servicio de Inalambricos, Ministerio de Correos y Telegrafos, Bogota, Colombia, informs us that the government has just finished a new short-wave station which will work on 49.35 meters (6,079 kc.) and which it is now testing.

Mr. Guy R. Bigbee, of Ft. Benning, Ga., says, "Germany announced a new short-wave transmission to be broadcast by DJO. I did not get the exact wavelength but I believe it was a little over 31 meters."

Mr. R. A. Stansfield, Ripley, Woking, England writes that VUB, Bombay, India, working on Wednesdays and Saturdays, at 11:30 A. M. to 12:30 P. M., E.S.T., on 31.36 meters

(9,570 kc.) is getting stronger each week; as are also the 25 and 49 meter transmissions of W2XE, Wayne, N. J.

Mr. Robert Pybus, Manchester, England, sends us the following schedule of ZHI, at Singapore, Straits Settlement. They are using 90 watts on 49.9 meters (6,100 kc.) and their schedule is Mondays, Wednesdays, and Thursdays from 5:40 to 8:10 A. M., E.S.T.; on Saturday, 10:40 P. M. to 1:10 A. M., E.S.T. Listeners wishing to verify this station should report on the Wednesday programs as these are the only ones that ZHI keeps a detailed log on. Station OER2, in Vienna, Austria, is now back on 49.4 meters (6,070 kc.) with 200 watts. Their schedule is Monday and Thursday, 9 A. M. to 1 P. M., and 2 to 5 P. M., E.S.T.

Mrs. Mary J. Eberts, Hollywood, Calif., writes that she tuned in JVM (10,740 kc.) at 9:15 P. M., P.S.T., to 10:45 P. M. They were calling KWU and also KVV.

Short-wave station COC, of Havana, Cuba, which burned to the ground several months ago is again rebuilding and will be on the air probably by the time this article goes to press.

Station CTIAA, in Lisbon, Portugal, on 31.25 meters (9,600 kc.) has greatly increased its power and is providing an Empire short-wave service for Portugal. It is announcing as "Radio Colonial," according to Mr. John Shanks.

Station OA4AD, continues to come in well on 51.90 meters until about 11 P. M., E.S.T. They usually announce in English just prior to signing off.

A short-wave station is being built at Suva, Fiji Islands, which will make use of, for the first time, the beautiful and melodic voices of the natives of the islands. It is said they possess unusual musical talents.

The short-wave station on 31.58 meters (9,500 kc.), which is on from 5:30 to 6:15 P. M., E.S.T., daily, and which has been variously reported as PSK, FRA3, and PRBA has now announced its call letters as PRF5 of Rio de Janeiro.

KDKA DX Club

No DX-er can afford to miss the half-hour weekly meeting of the KDKA DX Club, which reviews all the latest in broadcast and short wave tips. This programme is transmitted weekly at 11 to 11:30 P. M., E.S.T., over KDKA, and W8XK. The Club has been meeting on Saturday nights, although this may be changed to Sundays during the winter season.

Monthly Award of Subscription

Each month the editors of RADIO-CRAFT will award a one-year subscription to this magazine to the DX-er submitting the best verified list of stations received. These lists will be gone over and carefully considered by your DX Editor, and the winner announced in the succeeding issue of RADIO-CRAFT.

BROADCAST BAND TRANSATLANTIC RECEPTION

P.M.	E.S.T.	(EARLY EVENING RECEPTION)	STATION	COUNTRY	INTERFERING STATION
Time In At	FREQ.	WATTS			
Dark—8:00	574	100,000	Stuttgart	Germany	
Dark—6:30	785	120,000	Leipzig	Germany	WGY
Dark—7:30	795	5,000	Barcelona	Spain	(EAJ1) WGY-WBAP
Dark—7:00	841	100,000	Berlin	Germany (Tegel)	
Dark—7:00	904	100,000	Hamburg	Germany	
Dark—7:30	913	60,000	Radio Toulouse	France	
Dark—8:00	950	17,000	Breslau	Germany	
Dark—7:15	1,095	7,000	Madrid	Spain	(EAJ7) KMOX-WPG
Dark—8:00	1,195	17,000	Frankfurt	Germany	WOAI
Dark—10:00	1,456	10,000	Radio Normandie	Fecamp, France	
A. M.	E.S.T.	(EARLY MORNING RECEPTION)			
12:01-1:35	574	100,000	Stuttgart	Germany	
12:01-1:00	638	120,000	Prague	Czechoslovakia	
12:01-3:00	785	120,000	Leipzig	Germany	
12:01-2:30	904	100,000	Hamburg	Germany	
12:01-1:00	1,004	13,500	Bratislava	Czechoslovakia	
12:01-2:50	1,031	60,000	Konigsberg	Germany	
12:01-2:50	1,031	17,000	Frankfurt	Germany	
12:01-1:35	1,195	100,000	Munich	Germany	
12:30-0n	740	100,000	Budapest	Hungary	
12:45-1:00	540	120,000	Rome	Italy (Saturday A.M.)	
1:30-2:00	713	50,000	Milan	Italy (Saturday A.M.)	
1:30-2:00	814	50,000	Turin	Italy (Saturday)	
1:30-2:00	1,140	10,000	Horby	Sweden (Saturday)	
1:45-2:00	1,131	60,000	Radio Toulouse	Toulouse, France (Sat.)	
2:00-3:00	913	10,000	Radio Normandie	Fecamp, France	
2:00-3:00	1,456	100,000	Poste Parisien	Paris, France	
2:10-3:00	959	60,000	Beromunster	Switzerland	
2:45-3:00	556	60,000			

FOREIGN DX SCHEDULE FOR NOVEMBER-DECEMBER

DATE	E. S. T.	FREQ.	WATTS	CALL	LOCATION
Nov. 11	3:00-4:00 A.M.	1,270	1,500	H1X	Santo Domingo City, Dom. Rep.
Nov. 11	5:30-6:30 A.M.	1,145	850	4BC	Brisbane, Australia
Nov. 24	11:00L	1,030	10,000	NEB	Mexico, D. F., Mexico
Nov. 24	11:00L	6,010		NEBT	Mexico, D. F., Mexico (S. W.)
Dec. 11	3:00-4:00 A.M.	1,040	10,000	CP4	Radio Ilimani, La Paz, Bolivia
Dec. 10	2:00-3:30 A.M.	830	25,000	LR5	Buenos Aires, Argentina
Dec. 21	1:00-3:00 A.M.	682	1,000	HJN	Bogota, Colombia
Dec. 21	1:00-3:00 A.M.	6,079			Bogota, Colombia (S. W.)

Please Say That You Saw It in RADIO-CRAFT

VARIABLE OUTPUT P.A. AMPLIFIER

(Continued from page 347)

bined amplifier (gain of 26.8) and phone inverter: as a triode driver (with a gain of 35); or, as a twin class B output requiring only 300 volts on the plates to produce 10 watts of audio output. By using two of these tubes (each one with grids and plates tied together) in a balanced push-push circuit together with high-grade and efficient input and output transformers as well as a power supply of good regulation, 12 1/2 watts per tube is easily attained without any increase of third-harmonic distortion. Two tubes arranged in a push-push output channel will deliver 25 watts of virtually undistorted audio in each such channel. When 4 tubes are employed (Fig. 1) in two channels a total of 50 watts is produced!

Universal Operating Feature

By employing a 5 prong amplifier power socket (Fig. 1) which has connected to its filament, plate, and cathode prongs the filaments, B+ power lead and ground of the amplifier, it becomes a simple matter to use the interconnecting plug shown at B in Fig. 2, for connecting the amplifier power supply. This 6 volt power supply, which is composed of a dynamotor delivering 310 volts at 110 ma. (and its associated R.F. and A.F. filters) is equipped with an auxiliary socket for an additional dynamotor which is required when full 50 watts of audio output is being delivered by the amplifier. The auxiliary dynamotor (C, Fig. 2) is furnished with its own R.F. filter system and plug for insertion into the auxiliary socket.

It should be remembered that the amplifier may be built with either, and only one of the power supplies (6 volt D.C. or 110 A.C.) built directly into the chassis (depending upon the immediate use to which the amplifier is to be put). The other power supply (to permit universal operation) may be built at some later date if it ever becomes necessary to operate the system from some source of power other than that for which it was originally equipped.

This universal operating feature is a virtual guarantee against the amplifier ever becoming obsolete, and will also avoid the necessity of another amplifier for either 6 volts D.C. or 110 volts A.C. operation.

Filament Circuit

Figure 2D shows the filament circuit of the amplifier. Particular attention is called to the series connection of the type 45 tubes, which permits their 2.5 volt filaments to be operated from 6.3 volts. A center-tapped, 0.8-ohm, 5 watt resistor furnishes the exact mid-point of the filament system which is grounded through the 575 ohm biasing resistor shown in Fig. 1.

In Fig. 2D one of the poles of the "5 to 25 watts" switch is shown connected in series with the first- and second-channel tubes, this opens the filament circuit (and saves 3.2 amps.) when the 5 watt output is being used. Similarly, one pole of the "25 watt to the 50 watt" switch is connected in series with the second-channel tubes, only, to effect a similar economy when a power output of 25 watts is being produced. If it should become necessary to provide for instantaneous change-over from 25 to 50 watts output, without waiting for the cathodes of the second-channel tubes to come up to operating temperature (an interval of about 10 seconds is required), the second-channel filament switch may be shunted out of the circuit at will by wiring the contact point of the switch to the grid terminal of the amplifier power socket (fig. 2D) and adding a temporary (or permanent) jumper from grid to "F+" in the 5 prong plug of the interconnecting cable shown in Fig. 2E.

50 Watt Class "B" Output Stage

A large number of sound technicians have been disappointed in class B systems because listening tests have shown the output quality below par, although the circuit carefully checked with authentic designs. In such cases the trouble is nearly always due to a radio-frequency oscillation (because of the dynatron "kink" in the grids of most class B tubes) of the output stage which is present only when an audio frequency signal is applied and is easily mistaken for distortion caused by a high harmonic content of the output signal. This condition is easily remedied by using the speaker-correction network employed

New RADIO CITY TESTING EQUIPMENT

Assures *EFFICIENCY* at *Surprisingly-LOW PRICES*

RADIO CITY Tube Testers and Analyzers are **ACCURATE** and **DEPENDABLE**. They meet every requirement of modern service or laboratory work and are so flexible they will not become obsolete for many years.

The new models have features every service man will appreciate—not the least of which is their low first cost and economical maintenance. Available completely assembled and wired, or in money-saving kit form.



New Line of MULTITESTER and ANALYZER UNITS, including Analyzer Cable, Plug and Adapter Sets

New "304" TUBE TESTER

The only tube tester showing leakage above one-million ohms. "Neon-light" indicator. "Good-Bad" meter. Separate line-voltage meter. Tests all present tubes and provides for 50% increase. One-button operation. Counter and portable models. Etched metal panel; leatherette case.

\$19.95
Complete, ready to use
\$15.65
Kit, complete

Write Dept. RC-12 for FREE Data Sheets

RADIO CITY PRODUCTS CO.

48 West Broadway, New York City

NATIONAL UNION TUBES

QUALITY

PROFIT

SHOP EQUIPMENT

SALES AIDS SERVICE AIDS

COMPLETE INVENTORY PRICE PROTECTION

OWN ALL 5 RIDER SERVICE MANUALS

You can have the complete library of five volumes for a deposit of only \$10.00 and a National Union tube purchasing agreement. The deposit is refunded as a merchandise credit when you complete your agreement.

OWN ANY 4 RIDER SERVICE MANUALS

Or maybe you only want four volumes. In this case you deposit * only \$9.00, sign your agreement and the books are shipped immediately. What an opportunity to own a fine service library!

OWN ANY 3 RIDER SERVICE MANUALS

If you already have some of these books but want three to complete your set, you deposit * \$7.50, sign the agreement and get any three you need. Imagine 3 Manuals for a deposit that is the regular cost of one! Don't miss the chance.

OWN ANY 2 RIDER SERVICE MANUALS

Provided you need only two books deposit * just \$5.50, sign a National Union tube purchasing contract and the volumes are shipped at once. Don't fail to take advantage of one of these offers!

OWN ANY 1 RIDER SERVICE MANUAL

Perhaps you want but one volume. A \$3.00 deposit * and agreement brings it to you! (The new Volume V is of course, included in these offers) Act now! Get full details!

* Note: All deposits refunded as merchandise credits.

DON'T MISS THIS CHANCE TO OWN THE INDUSTRY'S GREATEST RADIO SERVICING LIBRARY!



ONE MONTH LIMIT!

Act quickly! These offers are limited. This is a rare opportunity to get a fine complete set of servicing manuals! You can't conduct a service business without these books. Imagine, the complete set covers more than 5300 models of nearly 250 manufacturers in the astounding total of approximately 5200 pages. You need these books National Union wants you to own them. That's why they've made this special limited offer. Don't miss it. Write at once!

National Union Radio Corp. of N. Y.
400 Madison Avenue,
New York City. RC12-34

Tell me more about.....
Name.....
Street.....
City..... State.....

SCOOP!

FOR EVERY SERVICE MAN IN THE 1935 ALLIED FREE CATALOG

The most complete and truly timely book in radio. More than 100 amazing pages. Not a skimpy, seasonal catalog whose usefulness is confined to a few weeks—but a true Radio Profit Guide—remarkably complete, up-to-the-minute, geared to radio progress.

- **NEW** An amazing line of Test equipment: New Supreme 5" Full Vision Meters; Triplet's magnificent new Master Instruments, etc. Prices are astonishingly low.
- **NEW** Radio's most complete stock of perfect standard line replacement parts. New volume controls, transformers, resistors, condensers. Clean merchandise at consistently lower prices.
- **NEW** An entirely different line of kits for custom set-building. Band-spread types. Short-Wave, All-Wave, Superhets and TRF circuits. A great selection for new profits.
- **NEW** The greatest P.A. array in radio. 3 to 50 watts, electric, 6 Volt Mobile, etc. Prices are unbeatable. Profit opportunities are doubled.

SEND FOR YOUR COPY TODAY

ALLIED RADIO CORPORATION

833 W. Jackson Blvd., Chicago, Dept. D

Please send me your FREE 1935 Catalog—the Radio Serviceman's Profit Guide.

Name _____

Address _____

City _____ State _____

Build Your Own Wheatstone Bridge For \$41.50

A simple, rugged, wide-range Wheatstone Bridge for resistance measurements. Operation identical with best laboratory instruments. Sensitive, accurate. Low cost. Kit easily assembled.



SHALLCROSS No. 630 Kit \$41.50
Assembled \$49.70

Built around a highly sensitive galvanometer and Shallcross Resistors. Range .01 ohms to 11.1 megohms. Send 6c in stamps for Bulletin 630-P.

SHALLCROSS MFG. COMPANY
Electrical Measuring Instruments and Accurate Resistors.
700 MAC PACE BOULEVARD
COLLINGDALE, PA.

in both output channels of the amplifier (3,000 ohm resistor in series with a .04-mf. condenser across each side of the center-tapped primaries of the output transformers). While this speaker output filter removes R.F. oscillation from the output signal, it also functions to maintain a uniform load for the output power tubes at all frequencies.

Inasmuch as the 6A6 is quite inexpensive it becomes feasible to use four of them in a push-push parallel input circuit arrangement with separate push-push output circuits. The output transformer of each 25 watt output channel will easily handle 35 watt peaks (70 watt peak total). Terminations are provided for 200 and 500 ohm line as well as for up to 25 ohm voice coils; additional taps are provided for 1.5, 3, 5, 8 and 16 ohms.

The output transformers are designed to maintain a relatively low inductance during full power output in order to avoid damage to loudspeakers usually caused by large excursions of the voice coil which ordinarily occur at some low-frequency resonant point. At medium values of power output (up to 15 watts) the inductance of the primary is considerably raised due to the permeability characteristics of the core. This phenomenon naturally raises the average efficiency of the transformer and greatly improves the low-frequency response at medium-volume levels.

Both channels may be used advantageously for broad-band (wide range) reproduction by utilizing appropriate high-frequency, middle-frequency and low-frequency speakers together with their respective filter networks.

Power Supply

Since the D.C. required by the class B stage fluctuates considerably between "full" and "no-load" operating conditions, special precautions must be taken in the design of the filter and power supply circuits in order to maintain proper and practically constant voltages regardless of the current drawn. The 83 mercury vapor rectifier employed provides for a constant internal voltage drop of 15 volts regardless of the current consumed, and thereby considerably helps to maintain the excellent voltage regulation characteristics of the system. Of course, the D.C. resistance of the high-voltage winding of the power transformer must be kept to a low value (maximum of 200 ohms for total secondary) so that any undue voltage drop cannot take place within the transformer itself.

The 6 volt operated dynamotors (used for storage battery operation) are capable of a voltage regulation better than 5%. (The voltage regulation of the A.C. power supply is 4 1/2% — a condition which assures equivalent operation of the amplifier proper from either source of power supply).

Another important factor in the maintenance of the excellent voltage regulation of the system lies in the proper design of the filter circuit. It will be noted that the high-voltage filter system is wired as an integral part of the amplifier so that the same filter components are used for 110 volt A.C. and for 6 volt storage battery operation.

The resistance of the filter choke CH-1 (which is the only filter choke in the class B stage) should not exceed 50 ohms in order to avoid large voltage drops across this unit. Two additional 30 henry chokes are used to supply hum-free power to the first three A.F. stages, while plate supply voltage for the class A drivers is tapped after the second choke.

As will be noted from Fig. A, the entire amplifier system is housed in a well-ventilated and handsome black crackle finished, high-permeability steel case. The approximate, overall dimensions of the unit are: 19x11x12 ins. wide.

List of Parts

- INPUT MIXER CONTROL PANEL.
- One Columbia line transformer, type UMA50B;
 - One Columbia phono. pickup transformer, type UMA50B;
 - One Columbia radio coupling transformer, type UMA50B;
 - One Columbia microphone transformer, type UMA50B;
 - Four Centralab 50 ohm resistors (1/2-watt);
 - Four Centralab 50 ohm "T" pad attenuators;
 - One Centralab 200 ohm "T" pad attenuator;
 - Six D.P.D.T. toggle switches;
 - One Weston 0-25 ma. milliammeter (Model 301);
 - One Columbia 200 ohm-to-grid transformer, type UMA50B;

Please Say That You Saw It in RADIO-CRAFT

There's plenty of

Servicing Material

in the 1934 Manual

Radio Service Men and others engaged in various branches of radio know the importance of the GERNSBACK Manuals, and how much they depend on them for reliable information. Whether for public address work, receiver diagrams or tube information, the material needed is certain to be found in one of the volumes of the OFFICIAL RADIO SERVICE MANUAL.

Contents of the 1934 Manual in Brief

Diagrams and service notes, more complete than ever before in any manual. Voltage readings for practically all sets, as an aid in checking tubes and wiring. All values of I.F. transformers used in superheterodynes, with the manufacturers' own suggestions as to correct balancing. A complete compilation of radio tube data, covering both old and new types. A complete list of American broadcast stations with their frequencies in kilocycles; extremely useful in calibrating test oscillators and receivers. Free question and answer service. No theory; only service information in quickly accessible form. A handy, easily-consulted master index making it easy to find almost anything pertaining to service problems, instantly. This index includes all the diagrams published in all the previous GERNSBACK manuals, as well as the 1934 diagrams. A big convenience and time saver.

400 PAGES
Over 2,000 Illustrations
9 x 12 Inches

Flexible Looseleaf Leatherette Cover

ORDER TODAY! No need to delay sending us your order—the 1934 MANUAL, like its predecessors, is a necessity in your business. We strongly advise you to order your copy today.

\$3.50 LIST



1934
Official Radio Service Manual
Complete Directory of 1933-1934 Radio Receivers
Full Radio Service Guide

GERNSBACK PUBLICATIONS, INC.
99 Hudson St. New York, N. Y.

GERNSBACK PUBLICATIONS, Inc.
99 Hudson Street, New York, N. Y.
Enclosed find my remittance of \$3.50 for which send me, Postage Prepaid, One Copy of the 1934 OFFICIAL RADIO SERVICE MANUAL. [Send remittance by check or money order; or register letter if it contains cash, currency or unused U. S. Postage stamps.]

Name _____

Address _____

City _____ State _____

**THE SET YOU HAVE
ALWAYS WANTED**



the "MJ" for the truly critical
There is no finer all-wave receiver
Write for Details

PIONEER SOUND LABORATORY
135 Liberty St., New York, N. Y.

**A hit!
The 7-POINT
MICROPHONE**

Here's why the Amperite Velocity Microphone gives you the best in quality and value: (1) Wider frequency range. No peaks or distortion. (2) Directional quality makes it easy to eliminate feedback. (3) Wider area of coverage. One Amperite Vel. Mike will replace several diaphragm type mikes. (4) Not affected by temperature, weather conditions or age. (5) Rugged construction. (6) Best value in mikes, or money refunded. (7) Fully guaranteed for two years against any service costs. Order from your wholesaler.

THIS

NOT THIS

AMPERITE CORPORATION 51 BWAY N. Y. C.

**AMPERITE
VELOCITY MICROPHONE**



**NEW! SHEET METAL
PUNCH FOR
Servicemen
Experimenters
Amateurs**

Knock out those socket and electrolytic condenser holes in METAL chassis easily and quickly in 5 seconds. All you need is a KAY PUNCH and a hammer. Hole sizes 3/8", 5/8", 1 1/8", 1 3/8".

\$1.75 Your price each, net.
Punches are made of cyanide hardened steel. Shp. Wt. 2 1/2 lbs. Remit by check or money order for full amount.

KAY SPECIALTY MFG. CO.

Obtainable in various sizes to meet your requirements 119 S. BROOM ST. MADISON, WIS.



**UNIVERSAL
Stretched Diaphragm Type
MODEL "XX"**

Here is microphone value without precedent! A brand new 1931 model stretched diaphragm type. Full Diaphragm Protection 2-button microphone. Exceeds every reasonable requirement for quality performance. Dealers' Net, \$5.88.

Universal Microphone Co., Ltd.
424 Warren Lane, Inglewood, Calif., U.S.A.

One Centralab 500 ohm potentiometer;
Four 6 volt pilot lights.

AMPLIFIER

- One Columbia interstage push-push transformer, type UMA50B;
- Two Columbia output transformers, type UMA50B;
- Three Centralab 0.1-meg. resistors (1/2-watt);
- One Centralab 3,000 ohm resistor (1 watt);
- One Centralab 0.25-meg. resistor (1 watt);
- Seven Centralab 50,000 ohm resistor (1 watt);
- Seven Centralab 25,000 ohm resistor (1 watt);
- One Centralab 2,000 ohm resistor (1 watt);
- Three Centralab 0.5-meg. resistor (1 watt);
- One Centralab 10,000 ohm resistor (1 watt);
- Two IRC .4-ohm 5 watt resistors;
- One IRC 875 ohm 10 watt resistor;
- One IRC 20,000 ohm 20 watt resistor;
- Four IRC 3,000 ohm resistors;
- Two Solar 25 mf. 50 volt electrolytic condensers;
- Two Solar .25-mf. 200 volt paper condensers;
- Five Solar .1-mf. 400 volt condenser;
- One Soiar Dual 8 mf. 500 volt electrolytic condenser;
- One Solar triple 4 mf. 500 volt electrolytic condenser;
- Two Solar .1-mf. 200 volt condenser;
- Two Solar 10 mf. 100 volt electrolytic condensers;
- Four Solar .04-mf. 500 volt paper condensers;
- One Solar triple 8 mf. 500 volt electrolytic condenser;
- One Solar 50 mf. 25 volt electrolytic condenser;
- Two General Transformer Co., chokes, 500 ohms 30 hy.;
- One General Transformer Co., choke, 50 ohms 30 hy.;
- Two 4 pole double-throw anti-capacity switches;
- One D.P.D.T. switch.

6 VOLT POWER SUPPLY

- 110 or 220 Volt Power Supply
- One Columbia Power Transformer, type UMA50B;
- One on-off switch;
- One 3 A. fuse.

MISCELLANEOUS

- Two Columbia dynamotors 300 volts 110 ma. (5% regulation). Type UMA50B;
- Four Solar .25-mf. 200 volt condensers;
- Two Solar .25-mf. 500 volt condensers;
- Two Columbia "A" R.F. chokes, type UMA50B;
- Two Gen-Ral 64 millihy. "B" chokes;
- One Columbia drilled and stamped chassis, shields, nameplates and control panel shield;
- One Set of hardware, wire, solder, etc.;
- One Set of blueprints, wiring instructions, and pictorial diagrams.

The forthcoming issue of RADIO-CRAFT will contain further interesting design data concerning this high-power P.A. amplifier.

**THE AEROVOX
"RESEARCH WORKER"**

How many technicians are aware that for a half-dollar per year they can receive, each month, a fine little publication containing new and original technical information "hot out of the lab."? We are referring to THE AEROVOX RESEARCH WORKER.

"Factors Affecting the Fidelity of Radio Receiving Circuits," is the title of the feature article in the February, 1934 issue of "RESEARCH WORKER"; due to the exceptional interest in this subject the publisher of this 4 pg. issue has offered to send a copy of it gratis to anyone interested in high-quality reproduction, whether in the short-wave region or the broadcast band.

Write for Item No. 603.

**HAMMARLUND
Low-Loss COILS
and COIL FORMS**

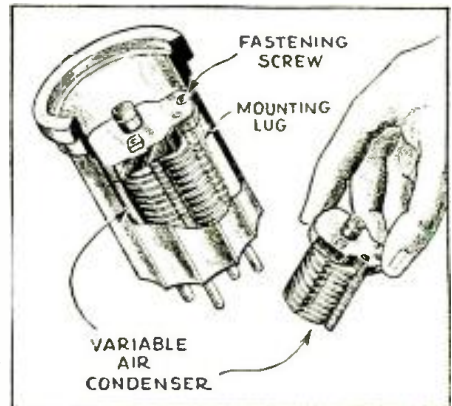

PERFECTION of the remarkable "XP-53" low-loss dielectric now makes it possible to offer highly-efficient S-W Coils and Coil Forms at the lowest prices in Hammarlund history. They are rugged and free from loss-causing artificial coloring. Ribbed for air-spacing and equipped with easy grip and "Meter-Index." Four, five or six prongs. Coil Forms, 35c and 40c each. Coils, \$3 and \$3.75 per set of four.

Several new types of compact Hammarlund Condensers are now available for trimming, balancing, padding and transformer-tuning.



"IBT" Mica-Dielectric Trimming or Padding Condenser.

Some are made to mount inside of coil forms or shields. (See illustration). You will find them accurately rated, constant and reliable under the most severe conditions.



"APC" Air-Dielectric Trimming or Padding Condenser.

HAMMARLUND MANUFACTURING CO.
424-438 W. 33rd St., New York.

— Check here and attach 10c for 16-page Hammarlund 1935 Short-Wave Manual, illustrating and describing most popular S-W circuits of past year, with schematic and picture diagrams and parts lists.

— Check here for FREE Information on XP-53 Coil Forms and Coils.

— Check here for FREE General Catalog.

Name

Address

RC-12



Please Say That You Saw It in RADIO-CRAFT

Train Now for New RADIO Opportunities



Get Into a Line Where There's Action—Every Day—And a Payday Every Week—You Be the Boss!

Analyzer & Resistance Tester—Latest Design—YOURS Without Extra Cost

Right now while hundreds are looking for work where there isn't any, the radio service field can use trained men. With the proper training and the necessary equipment you can enter this field and make a comfortable living. We include with our course this modern set analyzer and trouble shooter without any extra charge. This piece of equipment has proved to be a valuable help to our members. After a brief period of training, you can take the set analyzer out on service calls and really compete with "old timers." We show you how to wire short-wave receivers—analyze and repair all types of radio sets—and many other profitable jobs can be yours. Teaching you this interesting work is our business, and we have provided ourselves with every facility to help you learn quickly yet thoroughly. If you possess average intelligence and the desire to make real progress on your own merits, you will be interested.

ACT NOW—MAIL COUPON

Start this very minute! Send for full details of our plan and free booklet that explains how easily you can now cash in on radio quickly. Don't put it off! Write today **SEND NOW!**

RADIO TRAINING ASSN. of AMERICA
Dept. R-12, 4513 Ravenswood Ave., Chicago, Ill.
Gentlemen: Send me details of your Enrollment Plan and information on how to learn to make real money in radio quick.

Name.....
Address.....
City..... State.....

Dependable Sensational Performance!

BUD

Laboratory-Built P. A. Equipment

5 DAYS FREE Trial

Try **BUD** Sound Equipment For Five Days Absolutely Free!

PORTABLE SOUND SYSTEMS
ELECTRO-DYNAMIC UNITS
CARBON AND CONDENSER MICROPHONES - 4 & 6 FT.
ALL ALUMINUM TRUMPETS
FIELD EXCITERS-AIR COLUMN HORNS - LOW AND HIGH FREQUENCY UNITS FOR WIDE RANGETHEATRE USE

We manufacture and maintain our entire line at **BUD** laboratory built sound equipment. We suggest that you conduct your own comparison trial. We challenge you to duplicate **BUD** performance and **BUD** dependability at any price. Write today for literature, literature and prices and details of our **FREE FIVE DAY TRIAL** offer.

BUD SPEAKER CO.
1122 JACKSON ST.
TOLEDO, OHIO - U. S. A.

SOLAR ★

WET AND DRY ELECTROLYTIC PAPER AND MICA CONDENSERS

RECOGNIZED FOR SUPERIOR QUALITY IN ALL CLIMATES THE WORLD OVER

SOLD BY LEADING JOBBERS EVERYWHERE

SOLAR MFG. CORP.
599 BROADWAY
NEW YORK

BEST BY TEST!

ASK FOR CATALOG OF EXTREMELY COMPACT TYPES HANDY FOR SERVICE

OPERATING NOTES

(Continued from page 352)

cannot control the axial motion of the cone on low frequencies and high amplitudes of motion. Hence the cone's motion must be limited and I do this as shown in Fig. 2, using two small pieces cut from a "5 and 10" soft rubber sponge and placed so as to restrict high axial amplitudes of motion.

GULBRANSEN 8 TUBE A.C. CHASSIS

"SET noisy and intermittently dead," said the customer. The trouble could at times be brought on by hitting the chassis or cabinet but generally this was not effective. The three 24 R.F. tubes were poor and were replaced, the set cleaned and aligned, and all apparently was in good shape. As is usual it was left playing and, lo and behold, soon started to "cut up" in the shop!

The cause of all the trouble was a shorted 0.3-mfd. r.f. plate supply bypass condenser—one of three in a common can as shown in Fig. 3.

JOHN MUEHLKE.

R.C.A. VICTOR M-34

(VIBRATOR UNIT)

THE self-rectifying vibrator of the R.C.A. Victor M-34 auto-radio set is very difficult to adjust. However, vibrator trouble may be largely eliminated in the following manner. (Refer to Fig. 4.)

Disassemble the vibrator assembly and smooth the contact points. Reassemble and connect the primary and secondary contacts in parallel. Leave off the secondary leads and connect the primary wires as before. Mount a 5-prong wafer socket on top of the chassis by removing the first two screws holding the condenser gang and substituting longer screws with columns to space the socket from the chassis. This socket is used for an 84 in a conventional circuit shown at Fig. 1. The three wires leading to the plates and cathode of the rectifier are brought under the chassis through the holes beside the filter condenser block. Connect the wire formerly going to the power transformer secondary center-tap to the 84 cathode and ground the center-tap. Connect the outside ends of the secondary to the plates of the 84. Directly beneath the vibrator assembly, wire a 200,000-ohm 1-watt resistor across the secondary, and a .03-mfd. 600-volt condenser across each half of the winding. The condensers in the base of the vibrator assembly may be used if they are O.K.

The adjustment of the vibrator is not at all critical as compared to the highly critical adjustment formerly necessary when using the self-rectifying vibrator. The cost of the parts used is less than the cost of a new vibrator assembly.

The first set I changed in this manner has been in service over 8 months without requiring adjustment or service.

HAROLD L. KRAMER.

G.E. MODEL T-41

A LOCAL radio dealer brought me a G.E. model T-41 to repair. They had already spent considerable time on it and weren't able to find the trouble. The trouble manifested itself by excessive plate voltage (in the output stage), along with excessive current. Also, the screen-grid and plate potentials on the R.F. tubes and detector were excessive.

With these facts known, I re-tested all the voltages and found that there was no voltage across the speaker field. I therefore checked the speaker circuit and found that the filter choke had one lead (yellow with red tracer; see Fig. 5) grounding to its case. This lead is the one connected to the center-tap of the high-voltage secondary of the power transformer. Grounding of this lead connected the center-tap of the power transformer high-voltage winding, thus sending the full rectified but unfiltered voltage through the power tubes, detector, and R.F. tubes.

I took off the filter choke and inserted a piece of insulating paper between the case and leads. This cured the ailment. I replaced the choke and the set was fine.

A. G. MEUR.

FREE- YOUR CHOICE OF ONE OR MORE OF THESE POPULAR PREMIUMS

SHORT WAVE FANS! Here's a big treat for you—big, valuable premiums given absolutely FREE—many cost several dollars, and which you ordinarily would hesitate buying. Now, with each year's subscription to **SHORT WAVE CRAFT**, you get one or more of these attractive prizes. It's an excellent opportunity to get several books or a manual on short waves, one of a variety of beautiful world-globes or a world-time clock—all are available to those who subscribe to **SHORT WAVE CRAFT** on or before December 1st. Mail coupon for complete details.

A Word About Short Wave Craft

SHORT WAVE CRAFT today is the largest, most authoritative magazine of its kind in the world. Its unusual popular monthly radio features make each issue more valuable to short wave fans, hams, and experimenters... and service men as well. **SHORT WAVE CRAFT** is read by nearly 100,000 people. IT MUST BE GOOD!

25c The Copy

4-Color Cover 9" x 12"
Over 200 Illustrations

THE RADIO EXPERIMENTER'S MAGAZINE

TRUG CENTREBACK Editor

SHORT WAVE CRAFT

The Kitchen MARCONI

On All Newsstands

SHORT WAVE CRAFT RC-123
99 Hudson Street, New York, N. Y.

Send me, gratis, your interesting 1-page brochure, in two colors, which tells about the FREE premiums which you offer with subscriptions to **SHORT WAVE CRAFT**. I understand this subscription offer expires after December 1st.

Name.....
Address.....
City..... State.....

Please Say That You Saw It in RADIO-CRAFT

PHILCO—EARLY 90 AND 20

COMPLAINT, "no volume." A complete check-over revealed nothing wrong except very low plate voltage and practically no screen-grid voltage on the detector—the second-detector, in the case of the 90. Upon checking the bias section of the volume control it was found to have practically no resistance, thus causing practically a short to ground. This of course caused an excessive voltage drop in the divider resulting in the low voltages. The best repair is to replace the volume control, but as this was out of the question in several cases for various reasons, a 1,000-ohm, 1-w. resistor was inserted in this lead as shown at A in Fig. 6, and the set has operated perfectly for a year and a half.

C. S. BRITTON.

3 NEW TUBES

(Continued from page 343)

- Max. plate current, 4.5 ma.
- Mutual conductance, 2,000 micromhos
- Amplification factor, 25
- Plate resistance, 12,500 ohms

THE 80*—IMPROVED RECTIFIER

ALTHOUGH the radio tube business was nearly inundated by the great number of new tube types that flooded the market just prior to the manufacturers' agreement to a moratorium on new tube production, the sale of the type 80 rectifier has continued right along, flood or no flood, since the very first days of radio set operation from an A.C. power line.

However, certain gradual changes in radio set development have at last compelled a re-consideration of the suitability of the 80 as a rectifier. The more tubes a radio set uses, the more current the rectifier must supply, until, today, the power consumption by multi-tube sets has reached such figures as to greatly curtail the useful life of the standard type 80 rectifier.

The solution to this and some other problems was found in corrugating the plates, as this then gave the required increase in area and at the same time permitted the plate to enter through the neck of the bulb. (The 80*—"eighty star"—shown in Fig. B is one of these new "long life" 80's.)

This design results in considerably increased output capacity at the same life as previously, or very greatly extended life at the previous output current drain. In the first instance, the "corrugated-plate 80" has the same life at 150 ma. drain as the older 80 at 125 ma. output. In the second instance, the "new" 80 may be used as direct replacement for the "standard" 80 in any radio set without any circuit changes whatsoever, and when so used will afford very long life.

6A6 CLASS B TWIN-TRIODE

IN ORDER to meet, in the 6 V. power amplifier operation, the versatile services offered by the type 53 tube in the 2.5 V. tube line, a tube has been developed which incorporates all but the filament characteristics of the type 53 tube. This new tube, now making its bid for the consideration of the radio and public address technician, is known as the type 6A6. (The base connections of the 6A6 and 53 are identical.) Whereas the type 53 tube has a filament rating of 2 A. at 2.5 V., the 6A6 consumes only 0.8 A. at 6.3 V.

INFORMATION BUREAU

(Continued from page 354)

equal to $\frac{1}{1,000} = .377 CE$ where C is the capacity in microfarads and F is the voltage.

By transposition, the capacity in microfarads is therefore equal to $\frac{1}{.377 C}$

If the power factor of the condenser is also to be measured, it is necessary to connect to the circuit a watt meter to read the wattage loss. Since the currents involved are usually in the order of 6 amperes and the power factor is in the order of 5%, the watt meter must be able

(Continued on page 383)

The TURNER CRYSTAL MICROPHONE
Best For P.A. and Amateur Work



HERE is the ideal microphone for the P. A. operator. The perfect response and easy portability of the Turner Crystal Microphone (Brush Patents) exactly meet the requirements of this service. It will withstand rough handling without requiring adjustments. No background noise. No energizing current required. New diaphragm damping—exclusive! Turner feature—provides exceptionally flat response at all frequencies. P. A. operators and the better amateur stations from coast to coast are changing to the crystal mike. A circular describing this remarkable instrument will be sent on request.



The Turner Type G Crystal Mike lists at \$20. Discounts to P. A. operators and amateurs—40%. (Distributors—some territory still open.)

The Turner Type G is arranged for either spring or base mounting. Prices on either type mounting quoted on request.

SEND FOR FREE CIRCULAR

THE TURNER COMPANY - CEDAR RAPIDS, IA.

MULTI-TAP
UNIVERSAL OUTPUT
and INPUT Audio
TRANSFORMERS



No. 1337

MULTI-TAP OUTPUT

The Universal primary and the tapped secondary, from 2 to 20 taps in 2 ohm steps, makes it possible to feed practically any straight or push-pull output stage to any dynamic speaker. Universal—Physically may be mounted on end or side. Sets in best allow wide range of adaptability without rewiring panels. Overall dimensions: 2" x 2 1/2" x 1 1/2". Mtg. Grades: 1 1/2" x 1/2" to 1-9/16" or 1 1/2" x 1/2" to 1 1/2". Indispensable for Service Engineer's Emergency Stock.

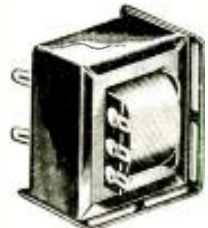

No. 3295

UNIVERSAL INPUT AUDIO

can efficiently feed any straight or push-pull audio stage on either A.C. or D.C. sets. A wide range of adaptability physically is made possible through the slotted end and side mounting bracket. Service Engineers should always have one or more in their emergency stock. Dimensions same as Output Transformer.

Free for the Asking!



"GENERAL" illustrated and fully descriptive BULLETIN No. 7 with complete list of 2986 models of tubes on which you can immediately restore original performance in case of transformer trouble out of a stock of only 5 models: Multitap power, one Multi-Tap Output and one Universal Input transformer.

GENERAL TRANSFORMER CORP.
504 So. Throop Street Chicago, Illinois

MAIL THIS COUPON

GENERAL TRANSFORMER CORP.
504 So. Throop Street,
Chicago, Illinois

Send me, without obligation, your new Bulletin No. 7 giving complete information regarding Multi-Tap products with which I can correct any radio failures caused by transformer troubles.

Name _____

Address _____

City _____ State _____



Announcing
a 50 WATT
P.A. AMPLIFIER



free

BIG NEWS FROM COLUMBIA

Here is the year's finest Public Address Amplifier! Equipped with a broadcast type Four Position Mixer, High-Gain Pre-Amplifier, High-Fidelity Voltage Amplifier and Phase Inverter, as well as a High-Powered Broad-Band Power Amplifier—five stages—all contained within one compact chassis! Operates from 110 or 220 volts AC or from a 6 volt storage battery. Write for low net prices and free pamphlet "What's New in Public Address Amplifiers."

FREE CONSULTATION: Our expert P.A. sound engineers are at your service. Write stating your prospects problem. Give full particulars. Our design engineer, Mr. Charles R. Shaw, will personally recommend the best type of sound system to employ and supply diagrams, cost estimates, etc. This service is free to dealers, servicemen and sound technicians. (Get our estimate before you buy.)

COLUMBIA SOUND SYSTEM CO.
135 A LIBERTY ST. NEW YORK CITY

Please Say That You Saw It in RADIO-CRAFT

**THE WORLD'S
MOST COMPLETE
CONDENSER LINE**



FOR

SERVICEMEN AMATEURS and EXPERIMENTERS

PAPER • MICA • OIL • ELECTROLYTIC

Backed by twenty-four years of scientific research and quality production. One billion since 1910. Available at all leading suppliers. Use a C-D the next time.

WRITE FOR OUR CATALOG TODAY

FOR

SERVICEMEN AMATEURS and EXPERIMENTERS

PAPER • MICA • OIL • ELECTROLYTIC

Backed by twenty-four years of scientific research and quality production. One billion since 1910. Available at all leading suppliers. Use a C-D the next time.

WRITE FOR OUR CATALOG TODAY

CORNELL-DUBILIER

CORPORATION

4347 BRONX BOULEVARD
NEW YORK

READERS' DEPARTMENT

(Continued from page 345)

be entirely impossible. If we were able to space speech modulation as close as 10 kc. at 3,000 megacycles, we would feel very satisfied. We had no intention of conveying the impression that we were trying to do any better than this.

I trust that this explanation will serve to correct any false impression which may have been obtained with regard to the results obtained with the ionic modulator, and that, if possible, steps be taken to bring this correction to the attention of your readers.

I. WOLFF,
Engineering Dept.,
Research Division,
RCA Victor Co., Inc.,
Camden, N.J.

We are glad to bring this data to the attention of our readers. It was our impression that this work was carried out under the direction of Mr. Wolff, hence the single "by" line.

We regret any misinterpretation that may have occurred—in editing the reference data available to us—due to our enthusiasm. The system developed by the authors is of exceptional interest to technicians, and we predict a tremendous future for "super-short wave waves," if we may so characterize this sphere of, what is now, experimental research.

Untold discoveries lie ahead for the experimentally-inclined radio man who is willing to devote his time and energy to development work in the "3,000 megacycle" band. Experimenters in this field are invited to write to RADIO-CRAFT, stating their progress in developing workable apparatus, and the results they are able to secure.

A NEW GIANT LOUD SPEAKER

(Continued from page 334)

the more essential and desired frequencies of sound. The microphone, of the "moving coil" type, is virtually a miniature of the loudspeaker operating in reverse. It does not respond efficiently to low frequencies and consequently transmits into the system only those frequencies most vital to intelligible speech.

The purpose of the speaker is both to shout long distances and to out-shout a tumult of noise, thus making it possible to give instructions, warnings, etc., where the spoken word even as amplified by previously existing speakers would be completely drowned out.

Few sounds produced by nature and classically associated with loudness can match the volume of the new speaker. It can make the voice louder than a clap of thunder. Measured at the mouth of its horn, the sound it produces is about 1,000 times louder than the roar at the foot of Niagara Falls.

Large crowds which stretch beyond the range of existing loudspeakers or are in the presence of enough din to drown them out could be handled by means of the new speaker, as could mass movements of people or soldiers. Fire fighters within burning buildings or deafened by the crackle of flames could be directed by the giant voice.

In rescues at sea instructions could be bellowed from the rescuing vessel to the distressed crew or to those in life boats, and if substituted for the usual fog horn the giant voice could give detailed advice rather than a simple warning.

The loud speaking system consists of three parts: an amplifier, a microphone and the loudspeaker itself, which is of the "moving coil" type. A coil of wire attached to the diaphragm is suspended in a powerful, steady magnetic field. Electric current, whose variations duplicate the voice waves, flows through the coil setting up a corresponding magnetic field around it which interacts with the field of the fixed magnet, forcing the diaphragm to move back and forth in synchronism with the variations in the current, and therefore reproduces on a gigantic scale the vibrations of the voice. The coil is 8 inches in diameter and is made of fine metal ribbon tightly coiled to a height of about an inch and a quarter.

The diaphragm is made of duralumin, .01-inch thick. Though driven by great power, the diaphragm actually moves no more than about .025-inch in either direction. When so moving, it generates a sound pressure of about 1 pound

Replace Auto-Radio Vibrators



with the
PIONEER
Gen-E-Motor

Don't fuss with troublesome vibrators that repeatedly fail! Replace them with the PIONEER Gen-E-Motor, the compact motor-generator unit that is used in the finest auto-radio sets. Easy to install. Guaranteed for one full year. No adjustments. No lubrication. Ask your jobber or write for FREE descriptive literature.

Also get full data on PIONEER D.C. to A.C. converters for operation from 6, 12, 32, and 110 volts.

Pioneer Gen-E-Motor Corp.
460 W. Superior St.—Chicago, U.S.A.

MODERN 10 TUBE ALL-WAVE SUPERHETERODYNE

(Continued from page 349)

because of this arrangement, see exactly what frequency range he is working on. The continuous-band-spread arrangement makes it possible to have band spread on every point from 13 to 550 meters. The large amount of spread incorporated in this receiver design, of course, makes it an excellent set for the short-wave fan who listens in on the 19, 25, 31, and 49 meter foreign bands, or the amateur that operates on 20, 40, 80, and 160 meters. These bands are spread over the dial to such a degree that tuning in a foreign station is as simple as that of a broadcast receiver.

A pre-amplifier or T.R.F. stage ahead of the first-detector greatly reduces the possibility of image response and improves the overall sensitivity and selectivity of the receiver.

The various bands are changed at will by previously described (triple) drawer coils. These coils are inserted directly between the large tuning dials, as shown in the photo. Automatic volume control is provided in this set and by a simple snap of a switch the volume can be controlled either manually or automatically. The A.V.C. circuit greatly reduces the fading on many foreign short-wave stations.

Circuit

Referring to the circuit diagram it will be ascertained that 10 tubes are used. A 58 is used in the tuned radio frequency stage for increased sensitivity and reduction of image response, a 57 first-detector and a 56 high-frequency oscillator. Two type 58s are used in the intermediate frequency amplifier which is tuned to 465 kc. Tuned standard Litz I.F. transformers (wound with Litz wire) are used. The C.W. beat oscillator is a 58 in the electron-coupled circuit. The duties of second-detector, automatic volume control stage and the first stage of audio, are performed by the 2B7 tube. This feeds directly into the two 2A5 power amplifier pentodes. Needless to say the speaker can be driven to full capacity and the "foreign" station reception will fairly shake the room.

Power Supply

The power supply is more than adequately filtered by 20 mf. of condensers to assure positive, hum-free reception necessary on the high frequencies. The 80 rectifier was chosen on account of its quiet operation characteristics. To insure high-fidelity output, a Wright-DeCoster speaker is used as standard equipment.

This receiver was tested out at one of our listening posts in the city along side of other custom-built receivers, and to the surprise of those present the short-wave stations received on this instrument were actually pulled in with the ease of tuning in a local.

List of Parts

Due to numerous parts necessary for construction of this set, and the special features of the coils and chassis layout, this information will be supplied only on request to those interested. Address all inquiries to the author, care of this magazine.





ALL-WAVE OSCILLATORS

1% accuracy. Grid stabilization
WORK ON AC OR DC

MODEL 37-S. Neon tube supplies modulation to 37-tube oscillator. Scale direct reading in kilocycles. Fundamental range 135-350 kc., 60-cycle modulation on A1 and neon tube modulation on D1. Dial also calibrated in 1/4th harmonic for broadcast band, 510-1500 kc. Complete with both tubes in black cracked steel cabinet for only **\$6.50**
Shipping wt. 3 lbs.

MODEL 37 AC. All Wave Three fundamental bands, 132-350 kc., 530-1500 kc., and 1320-3500 kc. are covered in the three switch positions. No charts or crystals to be consulted because 1% accuracy has been attained on the dial calibration. Engraved bakelite panel on black cracked steel cabinet. A.C. model complete with tube for only **\$9.50**
Shipping wt. 4 lbs.

COIL BOOK

Now book by Edward M. Shipe, B.S., M.E.E., gives number of turns for any inductance on a series of 48 accurate charts for any single-layer coil from 1/2" to 3" diameter. All insulations covered in charts. Complete with large chart supplement relating inductance, capacity and frequency **\$2.00**
Shipping wt. 1 lb.

DELTA RADIO CO.

135-C Liberty Street New York, N. Y.

Please Say That You Saw It in RADIO-CRAFT

per square inch. The mechanical force required to set up these pressures is about 50 pounds. The amplifier of the new system is capable of delivering 1,000 watts of speech current to the loudspeaker and the speaker of delivering 500 watts of energy to the air. Thus the efficiency is 50 per cent as compared to 25 per cent in the best commercial devices. When operating at full capacity the diaphragm coil dissipates about the same amount of heat as an electric flat-iron. This is radiated through an air gap to the magnet which in turn passes it off to the outer air.

The speaker and horn combined are 30 inches in diameter by 30 inches deep. The horn is of the folded type, and is made of cast aluminum and weighs about 125 pounds as compared to 375 pounds for the speaker unit itself.

The speaker and horn are mounted on a swivel mast and can be pointed in any direction. The entire system is controlled at the microphone by a single push-button which through a series of relays performs all the various operations necessary to start up or shut off the amplifier.

The system is the outgrowth of a steady evolution in the reinforcement of sound which had one of its first public demonstrations on Victory Way, Park Avenue, New York, during the 1919 Liberty Loan Drive. In the public address system used at the Republican National Convention in Chicago the following year the horns were 10 feet long. They were designed with 4 flat sides enlarging uniformly towards the mouth. Later the "morning glory" type of horn with the flaring mouth was adopted. Subsequently, the folded horn, considerably more compact, was found to be superior.

The first commercial loudspeakers were about one per cent efficient. Their diaphragms were made of bakelized linen and were 1 3/4 inches in diameter.

The system which was used to shout across the Hudson River, a distance of about a mile, from the roof of Bell Telephone Laboratories building early in 1928 consisted of 10 loudspeakers hooked into one horn. The new giant voice with its single speaker is many times more powerful.

THE MYSTERY SET

(Continued from page 334)

get the various stations. The power cord and plug were in plain sight, hanging loose at the left side. Everything was open and above board. You could walk around the set, look through the glass, in fact nothing was hidden.

How then could the set work? Plainly, it could not work by induction because you cannot work a radio set in this manner. The closest scrutiny of the set did not reveal any hidden wires. As no cement was used in joining together the panes of plate glass all corners were visible, and revealed—nothing! How is the mystery explainable?

The answer is: Ohm's law. Not so long ago, I did a little calculating, and found out that two No. 36 or even No. 38 copper wires connected in parallel, (or four wires, total,) were sufficient to carry the full load of a small radio set, such as the one shown, which only consumes approximately 40 W. The problem, therefore, resolved itself into hiding the wires in such a way that the closest examination would not reveal them. Since there are four corners to the cabinet, this was easily accomplished as follows:

The 110 V.A.C. power supply was split up into its two component lines. Then, green silk covered wire of No. 36 B. & S. gauge was fastened, by means of transparent cellulose cement, against the inside edge of each of the quarter-inch thick plate glass panes. Now it should be remembered that the edge of plate glass is green, and green silk wire against green glass is quite invisible, particularly when the wire is as fine as the one that was used. Unless you had a pretty good magnifying glass you could not possibly see the wire. To make the job perfect, the wire was run very close to the edge, and for this reason the wire was mistaken, by even the keenest observer, as the real edge of the glass. As no cement was used to cement the four pieces of plate glass together, there was actually an open space at each of the four corners, through which you could slide a card or piece of paper. Yet, with all this, the wire cemented on the inside edge of the plate glass remained undetected.

The four hair-fine wires were then run through

needle-like holes and sealed into shallow (1/32-inch deep) grooves in the underside of the lower wooden board. The four grooves converged to the center, where a standard plug receptacle was recessed into the baseboard. Two of the No. 36 wires were soldered to one terminal, and the remaining two leads to the other. Thus, the set could be plugged in from underneath the table (through which a hole was drilled) and the connecting wires were thus concealed. Needless to say, the A.C. connecting cord (and plug) which hangs at the left was disconnected from the chassis so that the plug would not be "alive"—it then was nothing but a dummy.

Now, as to the radio signal pick-up, the set in question is rather sensitive, and actually does pick up on the small one-foot aerial. In order to get more wire into the limited space available for an aerial, the wooden uprights (which are about a foot high) were wound with black wire which was then connected to the respective ends of the aerial, one black wire serving as part of the lead-in. This gave a small but efficient, concentrated antenna which was sufficient to pick up the programs of a few of the more powerful stations. (In locations where the pick-up is not so good, a superheterodyne five or six tube set would, of course, be preferable.)

This MYSTERY SET can be easily built by Service Men and others. It can be exhibited in windows or counters, and will create no end of discussion by the average onlooker or customer who will not understand as to how the set functions. The design is so simple that the cost of the entire device, outside of the inexpensive radio set, comes to less than \$4.00.

A few important constructional details should be noted. The grooves in the top of the wooden base and the underside of the wooden top must be deep enough—at least 1/2-inch in the upper, and 3/8-inch in the bottom board—to securely hold the plate glass. After the set has been completely assembled cement can be placed in the bottom and top grooves. The wooden top and baseboard will thus hold the plate glass firmly—so firm in fact, that you can pick up the entire set by grasping the upper board, although I do not advise that this be done as a routine thing. The method of running and connecting the top ends of the fine, green wires is as follows: exactly at the top edges of the plate glass panels where the green wires run off, drill a hair-like hole, for each lead, at an angle so that the fine wire will come through the top of the top board inside the boundary of the set chassis (out of sight). The same two fine wires connected to one socket terminal under the baseboard are also connected together underneath the chassis and to one of the two power connections from which the power cord was previously soldered. The remaining two fine wires solder to the second power connection underneath the chassis.

You will have a lot of fun in building this set and mystifying the local radio wiseacres.

A 5 TUBE MIDGET SUPERHET. SET

(Continued from page 349)

nique as applied to the broadcast-kit field is this 5 tube A.C.-D.C. superhet., a universal receiver of high efficiency. So simple is it in construction that even an inexperienced set builder can put it together in one evening and obtain immediate results. This set is ideal for the many people who like to make their own broadcast as well as short-wave receivers, and for Service Men with spare time on their hands who can sell it as a custom-built job for use in bookcases, desks, etc.

The A.C.-D.C. feature, made possible by the use of a 2Z5 rectifier tube and series connection of the tube heaters, eliminates the necessity for a bulky power transformer and permits the whole receiver to be built on a chassis only 10 1/2 x 4 1/2 inches deep. While practically every square inch of chassis surface is employed, the layout of parts is such that most of the connections are short and direct, and the wiring is really quite simple.

The purpose of the pre-selector stage is to provide enough selectivity ahead of the mixer tube to reduce image-frequency interference, a very annoying characteristic of ordinary superhets. Very few small supers. employ this feature, yet it is really essential for satisfactory reception.

Please Say That You Saw It in RADIO-CRAFT

MAKE MORE CALLS and BIGGER PROFITS

with New **READRITE** Point to Point **TESTER** • No. 720 •



If you want a point-to-point tester that is designed up to the minute, that has many exclusive features and advantages, that enables you to make more calls per day at less cost per call . . . get the facts concerning the new Readrite No. 720 unit. It operates faster, more efficiently, with less manipulation. It withstands severe field service. It tests all resistances, capacitivities, voltages, currents and capacities from the set socket by the reliable point-to-point method.

Two highly developed Vane-type AC and DC meters are incorporated in the new No. 720 tester. They are simple in design, fast in operation and dependably accurate in use. The DC scales are 15, 150, 300 and 600 volts, 15-150 milliamperes, AC scale 10, 25, 150 and 750 volts.

Your Jobber Can Supply You

. . . with the No. 720 Readrite Point-to-Point Tester at Dealer's net price of only \$15.00.

READRITE METER WORKS
133 College Ave. Bluffton, Ohio



MAIL COUPON FOR QUICK FACTS!

READRITE METER WORKS
133 College Ave., Bluffton, Ohio

Gentlemen: Send me catalog on Readrite No. 720 Point-to-Point Tester, as well as folder giving proof of Readrite leadership.

Name

Address

City State



new!
Moving Coil
Microphones

● An improved type of moving coil microphone is now available, at low cost, to the general Public Address, Broadcast and Talking-Recording trade. This instrument retains all the desirable characteristics of moving coil microphones—low impedance, permitting long transmission lines without noise pick-up; freedom from hiss, etc.; performance unaffected by atmospheric conditions, and operation while being moved around.

The new standard and deluxe models. Moving Coil Microphone offers the following features: wide-angle pick-up, which eliminates grouping; ricket construction; small dimensions, making concealment convenient, and high-quality pick-up, with response flat to 3,000 cycles and sloping 5 db. at 5,000 cycles, without resonance peaks. Specifications: field coil, 2 to 6 volts; voice coil, 20 ohms. (The Deluxe model is equipped with suspension yoke.)

Standard Model Moving Coil Microphone (without matching auto-transformer). Net price \$14.95

Matching Auto-Transformer (for use with above microphone). Net price \$3.95 additional.

RADIO EQUIPMENT CORP.

155 East Genesee St., Buffalo, N. Y.

Los Angeles Sales Representatives: Ben S. Rothenstein Company, 1028 So. Olive Street, Los Angeles, Calif.
New York City Sales Representatives: Albee Radio Corp., 16 Hudson Street, New York, N. Y.

WORLD'S FINEST RESISTORS



only "Certified" CONTINENTALS have

- Solid Molded Carborite
- 1000 Volt Insulation
- Welded Leads

Why not have the advantage of these outstanding super-abilities in resistor performance for repair work, see construction and experiments? For sale at leading jobbers the world over.

CONTINENTAL Radio Components

Auto-Radio Ignition Suppressors, Paper Dielectric Condensers and Auto-Radio Noise Filters are also described in the new CONTINENTAL Catalog.

WRITE FOR FREE CATALOG



13914 Lorain Ave.—Cleveland, Ohio, U.S.A.

When Choosing a Radio School . . .



RCA Institutes, with its reputation established by 25 years service is an institution recognized as an important factor in the radio industry.

Whether elementary radio principles or advanced subjects, sound applications, mathematics or practical radio engineering, RCA Institutes is prepared to give you the instruction you need.

RESIDENT SCHOOLS NEW YORK & CHICAGO

with modern standard equipment

EXTENSION COURSES FOR HOME STUDY

under convenient "no obligation" plan

Illustrated Catalog on Request.

R. C. A. INSTITUTES, Inc. Dept. RT-34
75 Varick St., New York—1154 Merchandise Mart, Chicago

The A.C.-D.C. power system looks a bit queer, but actually is simple. The 25Z5 consists of two separate rectifier units (plate and cathode) with a common heater for the cathodes. The plates are hooked together, but the cathodes are left separated. With direct current, the attachment plug is poled so that the upper lead in the diagram is positive. Current then flows continuously from the plates to the cathodes. The current through cathode A feeds the speaker field only; the current through cathode B provides plate and screen-grid voltage for the tubes. This split arrangement is important because it permits the use of a low-resistance choke in the L8 position, and thus keeps the voltage as high as possible. If the speaker field alone were used as the filter choke there would be so much of a voltage loss across it that the tubes would receive practically nothing.

With alternating current supply, the 25Z5 acts as a double half-wave rectifier, current flowing from the plates to the separated cathodes only during the positive half of the cycle. Condensers C15 and C16, in combination with L8, adequately filter the plate supply to the tubes, while C17 does the honors for the speaker field, which has a resistance of 3,000 ohms.

In actual operation this 5 Tube A.C.-D.C. superheterodyne shows up very well. With a 20-foot length of flexible wire (supplied with the kit) acting as the aerial, clear, interference-free programs are received with more than enough volume for ordinary room requirements. With the completed chassis mounted in a cabinet, the tone quality is excellent.

List of Parts

- One Trutest antenna coil, L1, L2, L3;
- One Trutest oscillator coil, L4;
- Two Trutest I.F. transformers, 175 kc., L5, L6;
- One Trutest speaker output transformer, L7;
- One Trutest 32 henry filter choke, L8;
- Three Trutest 3 gang tuning condensers, 365 mmf., C1, C2, C3;
- Three Cornell-Dubilier or Aerovox condensers, .001-mf., C4, C12, C11;
- One Cornell-Dubilier or Aerovox condenser, 50 mmf., C5;
- Three Cornell-Dubilier or Aerovox condensers, 0.1-mf., C6, C13, C14;
- One Cornell-Dubilier or Aerovox condenser, 0.2-mf., C7;
- One Cornell-Dubilier or Aerovox condenser, .01-mf., C8;
- One Cornell-Dubilier or Aerovox condenser, 25 mf., C9;
- One Cornell-Dubilier or Aerovox condenser, 100 mmf., C10;
- One Cornell-Dubilier or Aerovox condenser, 0.5-mf., C11;
- One Cornell-Dubilier or Aerovox condenser, 12 mf., C15;
- Two Cornell-Dubilier or Aerovox condensers, 1 mf., C16, 17;

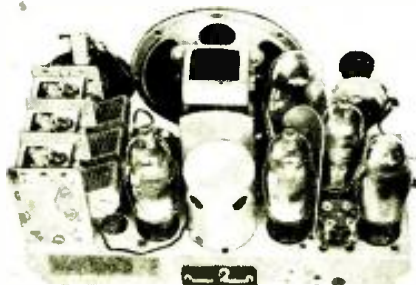

Fig. B
Rear view of midget 5 tube set.

Fig. C
Note the compactness, underside.



FREE
48-Page Supplement
to the Auto-Radio
Service Manual!

To everyone who now purchases the OFFICIAL AUTO-RADIO SERVICE MANUAL this 48-page Supplement is issued FREE. Practically all of the latest sets, together with servicing information will be found in these new pages. The new Supplement does not increase the cost of the book to you, but gives you an Auto-Radio Service Manual that is right up-to-the-minute with service notes.

Good Money in Servicing Auto-Radios

If you are overlooking servicing auto radios, you're missing a great deal of business. The auto-radio business had its greatest boom last summer when thousands of sets were sold. By now many of these same sets require servicing and with hundreds of them right in your own community, you can build up a good auto-radio servicing business. In a short time you can easily add 25% profit or more to your regular servicing business.

List of sets covered in the Manual

- | | |
|-------------------------------|---------------------------------|
| Arcne Radio Mfg. Co. | P. B. Mallory & Co. |
| Allied Radio Corp. | Melburn Radio Mfg. Co. |
| Atwater Kent Mfg. Co. | Montgomery Ward & Co. |
| Audion Radio Co. | National Co., Inc. |
| Auto-Rad Radio Company | Nashville-Sterling Int., Inc. |
| Automatic Radio Mfg. Co. | Philco Radio & Tel. Corp. |
| Carier General Corp. | Pierce-Airo, Inc. |
| Century Radio Prod. Co. | Premier Electric Co. |
| Chevrolet Motor Company | Radio Chassis, Inc. |
| Consolidated Industries, Ltd. | RCA-Victor Co., Inc. |
| Crosley Radio Corp. | Seaford Radio Corp. |
| DeLoe Appliance Corp. | Seavaks-Wilmington Corp. |
| DeLora Radio Corp. | Stewart Radio & Tel. Corp. |
| Emerson Electric Mfg. Co. | Stewart-Warner Corp. |
| Fada Radio & Elec. Corp. | Stromberg-Carlson Tel. Mfg. Co. |
| Federated Purchaser, Inc. | Transformer Corp. of Am. |
| Franklin Radio Corp. | United Amer. Radio Corp. |
| Galvin Mfg. Corp. | United Motors Service |
| General Electric Co. | U. S. Radio & Tel. Corp. |
| General Motors Corp. | Utah Radio Prods. Co. |
| A. H. Grebe & Co. | Well-Gardner Company |
| Grigby-Grumov Co. | Whelan Radio Serv. Co. |
| Chas. Hoodwin Company | Rudolph Wurzbach Mfg. Co. |
| International Radio Corp. | Zenith Radio Corp. |

\$2.50

Over 200 Pages
Over 500 Illustrations
9 x 12 Inches
Flexible, Loose-Leaf Cover

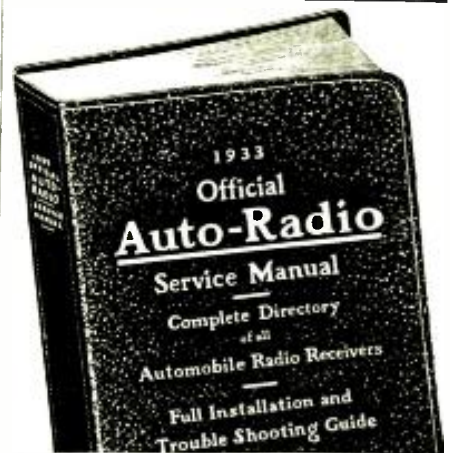

MAIL THIS COUPON TODAY!

GERNSBACK PUBLICATIONS, INC. RC-1234
99 Hudson Street, New York, N. Y.

Enclosed you will find my remittance of \$2.50 for which please send me One Copy of the OFFICIAL AUTO-RADIO SERVICE MANUAL with FREE 48-page Supplement. Send remittance in check or money order. Register letter if it contains cash or currency. WE PAY POSTAGE.

Name _____
Address _____
City _____ State _____

Please Say That You Saw It in RADIO-CRAFT

- One resistor, 130 ohms, R1;
- One Electrad resistor, 10,000 ohms (combined with line switch), R2;
- One IRC resistor, 75,000 ohms, R3;
- One IRC resistor, 40,000 ohms, R4;
- One IRC resistor, 5,000 ohms, R5;
- Two IRC resistors, 500 ohms, R6, R10;
- One IRC resistor, 20,000 ohms, R7;
- One IRC resistor, 250,000 ohms, R8;
- One IRC resistor, 500,000 ohms, R9;
- Two Sylvania or National Union type 77 tubes, V1, V3;
- One Sylvania or National Union type 78 tube, V2;
- One Sylvania or National Union type 43 tube, V4;
- One Sylvania or National Union type 25Z5 tube, V5;
- One dynamic speaker, 5½ ins. dia.;
- Formed and drilled chassis, sockets, wire, hardware, etc.;
- Detailed assembly instructions and full-size diagrams are supplied with the kit.

TUBELESS "B" UNIT

(Continued from page 344)

The output of this supply unit is approximately 50 ma. at 250 V. The voltage, under normal loads, is constant. A fuse in one of the "A" leads protects the unit and battery against short-circuit dangers.

Installation

For radio receivers in the home, the "A—" of the storage battery should be connected to the grounded terminal of the supply unit. The "A+" terminal of the storage battery then connects to the terminal marked "A+": (see "Note"). A switch may be connected in place of the fuse, at the terminals for turning the unit "on" or "off." Or, if desired, a 6 V. relay, (½-A. type) which is easily available, can be arranged so that when the receiver is turned "on" the relay will turn "on" the power unit. To do this the relay must be connected in series with one of the battery leads to the receiver so that the instant the tube filaments draw current, the relay magnet becomes energized and closes a contact circuit. These contacts control the power to the "B" supply unit. *DO NOT operate this "B" unit until a "load" has been put on it — until the radio set has been turned on.*

Note: For auto-radio installation work additional care must be exercised. The "A+" terminal of the unit must be connected to the "A+" terminal of the car battery. The "A—" terminal of the unit then connects to the "A—" terminal of the storage battery. Unless this precaution is rigidly observed at all times both the vibrator and the electrolytics will be burned out in a few seconds. Therefore, inasmuch as the case of the "B" eliminator is its "ground," then if the car battery has its positive terminal grounded to the automobile it will be essential that the "B" eliminator be entirely insulated from the car chassis, and only a paper condenser of 1 to 5 mf. capacity used to capacitatively couple the eliminator to the car ground (the chassis). However, if the car battery "A—" terminal is grounded, then the case which houses the entire "B" unit must also be grounded to the car with heavy braid connected to some chassis bolt, for the purpose of eliminating any possibility of ignition noise interference.

List of Parts

- One resistor, 0.5-meg., 1 W.;
- One resistor, 30,000 ohms, 1 W.;
- One resistor, 50,000 ohms, 1 W.;
- One resistor, 1,750 ohms, 5 W.;
- One resistor, 1,100 ohms, 5 W.;
- Two Cornell-Dubilier tubular condensers, .02 mf., 1,000 V.;
- Two Cornell-Dubilier electrolytic filter condensers, 8 mf., 525 V.;
- Four Cornell-Dubilier paper condensers, .5-mf., 250 V.;
- Two General Transformer R.F. "A" chokes (140 turns No. 15 wire), 1½ in. long, 3 layers on ½-in. dia. wood core, R.F.C.1, R.F.C.2;
- One General Transformer filter choke, No. 5112;
- One General Transformer R.F. "B" chokes, 6 millihenries to carry 50 ma., R.F.C.3;
- One General Transformer vibrator-inverter;
- One General Transformer power transformer, No. 411.

WEBSTER - Chicago

POWERFUL 15 WATT CLASS "A" AMPLIFIER

MICROPHONE CURRENT

MASTER VOLUME CONTROL

VARIABLE OUTPUT IMPEDANCE



No. 359

In the Series 359 Webster introduces an altogether new standard of excellence in Amplifier Equipment. Built around the new tubes and with the incorporation of new ideas in construction, this amplifier will show a greater utility in daily application on sound problems. Moderately priced yet powerful enough for all systems, dance halls, athletic fields, churches, schools, etc., the Series 359 most nearly meets the needs of sound installation engineers. Write for complete details.

CLASS "B" 26 WATTS

In the class B type equipment of the Series 359 Webster provides a definite advancement. This new equipment will handle a tremendous volume of undistorted output. Easily pushes four or five giant dynamic speakers. Write for complete description.

Write for Catalogue! Let us put your name on the Webster mailing list to receive bulletin on this unit and all our other equipment.

THE WEBSTER COMPANY

3830 W. LAKE ST.

CHICAGO, ILL.

Franklin Transformers

"Most Sock Per Dollar"

A few of the many outstanding values that can be secured at your nearest jobber or direct if he does not stock them.

GENERAL REPLACEMENT

No. 210 Pri 110 v. Sec 300-0-300—40 M.A. 2.5 V 5.5 Amp . . . \$1.11
5 V 2 Amp

No. 209 Pri 110 V. Sec 330-0-330—60 M.A. 2.5 V 8.75 Amp . . . 1.80
5 V 3 Amp

No. 1103 Single plate to P.P. grids98

SOUND

No. 521-B Double button mike to grid . . . 1.32

No. 802 P.P. 45 plates to 8-15 ohms95

No. 6131 Pri. for D.B. mike, 500 ohm line and tube plate3.30
or high impedance pickup. Sec. to single grid.

AMATEUR

A very complete line by Mr. Boyd Phelps. Illustration shows one type.

WRITE FOR CATALOGUES

(No. 70 contains a large number of up-to-date amplifier circuits.)

No. 51 General Replacement No. 70 Sound No. 52-C Amateur

FRANKLIN TRANSFORMER MFG. CO.

607-609 22nd Avenue N. E. Minneapolis, Minn.



COAST-TO-COAST PRESENTS A FULL LINE OF

1935 P. A. AMPLIFIERS

Never before such features!



Models available for operation from either a 6 Volt Storage Battery, or a 110 Volt A. C. Universa Models may be operated from both 6 Volts D. C. and 110 Volts A. C.

Employ an all-steel black crystalline housing with hinged top and ventilating louvers. Available with optional self-contained "Input-Mixer-Fader" Control Panel, Combination Output Meter and "Mike" Current Meter. Self-Contained "Mike" Current Supply, etc., etc.

Range in Audio Power Output From 5 Watts to 100 Watts!

FREE 100 PAGE RADIO AMPLIFIER CATALOG

Completely describes our new line of 1935 Amplifiers (52 models!) as well as All-Wave and Short-Wave Receivers and Converters, Inter-Office Call Systems, Test Equipment, Replacement Parts, Kits, Tubes, and Accessories at unbeatable net prices. Buy direct from the manufacturer and pay only one profit.



COAST-TO-COAST RADIO CORP.
123 K WEST 17th STREET, NEW YORK, N. Y.



Please Say That You Saw It in RADIO-CRAFT

SERVICE MEN'S ESSENTIALS FOR ALL MEMBERS OF THE ORSMA

WHAT ARE THE SERVICE MEN'S ESSENTIALS?

THE OFFICIAL RADIO SERVICE MEN'S ASSOCIATION has arranged to supply a number of "Service Men's essentials" for its members and associate members only. These essentials are priced at cost, plus a small additional fee which is the only source of income that the Association has. No one obtains any profit or benefit, except the Association itself. Whatever profit accrues, is reinvested for the furtherance and enlargement of the Association. By using the letterheads, billheads, etc., you present the business-like appearance to your customers. In addition, the Association has made arrangements with most of the prominent manufacturers to allow special discounts to members, providing ORSMA letterheads are used when ordering.



No. 14—50c each
(Plus 10c for Postage)



No. 5—50c each

No. 1 ORSMA LETTERHEADS

These letterheads, shown on the right, are furnished with your name, address and telephone number. Printed on excellent paper. They are sold in lots of 100 or multiples thereof, with a distinct saving for single orders of 1,000 or more. Per 100, 60c; per 1000, \$3.00.

No. 2 ORSMA ENVELOPES

These are furnished to match the letterheads, printed with your name and address and seal of the Association. They go hand in hand with the letterheads and are usually ordered in the same quantity. Per 100, 60c; per 1000, \$3.00.

No. 3 ORSMA SERVICE RECORD CARDS

These serve a double purpose; whenever you complete a job you fill out the report-bill and hand it to the customer; this is the "psychological moment" to collect. By the use of carbon paper a permanent record is kept. Furnished with name, address and telephone number. Per pad of 50, 60c; per 10 pads, each of 50, \$3.00.

No. 4 ORSMA INSPECTION LABELS

The label is to be filled in with the proper dates, and pasted inside the set or cabinet where the customer will see it. It is a continuous reminder to him that when service is needed, he can call you again. The advantage is apparent. Per 100, 60c; per 1000, \$3.00.

No. 5 ORSMA LAPEL BUTTON

At the suggestion of many members a handsome lapel button bearing the name and emblem of the Association has been designed. It signifies that you belong to the ORSMA; and in addition it gives your customers a better appreciation of the professional nature of your work. 50c each.

No. 6 ORSMA BUSINESS CARDS

These are furnished on a fine grade of paper in two colors with a blotter back. Thus they present an incentive to customers to keep them in a prominent place. They are printed with your name, address and telephone and bear the official seal of the Association. Per 100, 75c; per 1000, \$4.00.

Nos. 9 & 10 ORSMA EMBLEM CUTS

These cuts for printing, advertising, etc., are furnished in two styles and sizes. They may be used for newspaper or telephone-book advertisements or for printing of any kind. Large size, 1 1/4 x 1 1/4 in., \$1.35 each; small size, 3/4 x 3/4 in., \$1.20 each.

No. 11 ORSMA MEMBERSHIP SIGN

A set of three signs, printed on heavy cards, and having holes punched in order to hang in office or store. These are sold to members and associate members. Large enough to be quite prominent and the two tone effect makes them attractive. Set of three, 50c.

No. 12 ORSMA ADVERTISING DISPLAY SIGN

A two color sign printed in large letters with your name, address and telephone, with the seal of the Association. This sign is sold in quantities of 25 or more and is ideal for hanging in stores, offices, etc., for advertising purposes. Set of 25 cards, \$3.00.

No. 13 RADIO SERVICE MEN'S ASSORTMENT PACKAGE

This includes one gold filled lapel button, 100 letterheads, 100 envelopes, 50 service record cards, and 100 labels printed with your name and address as described above. The whole assortment costs only \$3.00—a worth-while saving. Complete, \$3.00.

No. 14 ORSMA MEMBER CERTIFICATE

A handsome diploma-like certificate engraved on stiff vellum-bond. The certificate is personally signed by the President and Executive Secretary and the corporation stamp of the Association is impressed on a red seal attached to it. Your name, certificate number and date of registration are lettered by hand and the certificate is mailed in a cardboard tube to insure safe delivery. Each 50c, plus 10c for postage.



No. 1—60c per 100
\$3.00 per 1000

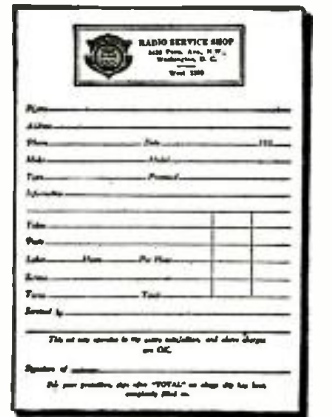

No. 3—60c per pad of 50
\$3.00 per ten pads, each of 50



No. 6—75c per 100
\$4.00 per 1000



No. 4—60c per 100
\$3.00 per 1000

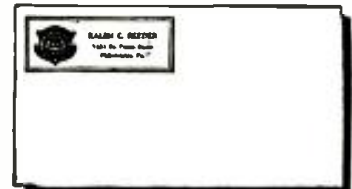

No. 2—60c per 100
\$3.00 per 1000

Application for Membership in ORSMA

Executive Secretary, ORSMA
99 Hudson Street, New York, N. Y.

Kindly send an application blank for
 Full Membership
 Associate Membership

Name

Street or Box

City..... State.....

RC-1134

OFFICIAL RADIO SERVICE MEN'S ASSOCIATION

99 Hudson Street, New York, N. Y. RC-1121

Please send me the following RADIO SERVICE MEN'S ESSENTIALS which I have selected from this advertisement. My remittance for \$..... is enclosed. Send remittance in form of check or money order. Register letter if it contains cash, currency or unused U. S. Postage Stamps.

.....

.....

.....

Name ORSMA No.

Address City and State

Please Say That You Saw It in RADIO-CRAFT

ORSMA FORUM

(Continued from page 346)

tube base. Insert the other wire through the socket and through the plate pin, feeding the other wires from the socket through their respective holes. Pull the plate leads up, as the socket is pushed down. Cement socket and tube base with collodion. Solder tips and cut off.
WILLIAM J. ARNST.

A CAPACITY TESTER

RADIO-CRAFT, ORSMA Dept.:

Here is a diagram of my instrument for measuring the capacity of condensers; Fig. 3. It will measure capacity from .0001 to 8 mf. in 3 steps. The transformer delivers about 300 V. When Sw. 1 is turned to LOW the range is from .0001 to about .02 mf. When both switches are set to MED. and Sw. 2 is set to HIGH the range is from about 1. to 8 mf. In the medium and high ranges the condenser is in shunt to the meter so the higher the capacity the lower the reading.

H. W. GALLES.

HOME MADE ANT. COUPLER

RADIO-CRAFT, ORSMA Dept.:

Here is an idea for you experimenters who cannot afford a set and antenna coupler for a doublet, or single line antenna.

This is the set coupler, using a 2-in. tube and No. 22 S.C.C. wire. See Fig. 4. L1 is 40 turns of wire close-wound and center tapped. Over this is placed a piece of wax paper, then a small piece of copper to be used as a shield, and another piece of wax paper. Next, wind on L2, 10 turns spaced 1 turn; wind in the same direction as L1.

The ant. coupler is made the same as the set coupler, only wind on L2 first and then L1, leaving out the copper strip. L1 does not have to be center tapped.

ORMAN F. JENKINS.

AN 18-36 WATT P.A. AMPLIFIER

(Continued from page 348)

the class A-B amplifier (class A prime). The class A amplifier is one in which the bias and A.C. signal voltages are such that the plate current of the tube flows at all times. The class B amplifier is one in which the tube is biased to a value which approximates cut-off value of the plate current with no A.C. signal voltage. The plate current in such an amplifier flows during approximately one-half of each cycle when the signal voltage is applied. The class A-B amplifier is an intermediate condition of operation between class A and class B. This type of amplifier is over-biased, operating as a class A system for small signal voltages, and as a class B amplifier when the signal voltages are large. In this type of system, the plate current flows through considerably more than one-half a cycle yet less than 360 degrees. The advantages of this amplifier are efficiency and an intermediate output between a class A and class B amplifier, with the amplifier acting essentially as a class A unit at low input levels and a class B unit at high levels. By obtaining, in class A-B connection, a considerable reduction in the "idle" plate current, ordinarily present in the class A amplifier using the same tube, the amplifier becomes quite economical to operate, economy of operation being one of the desirable characteristics of class B amplification. Most of the low level distortion in class B amplifiers is eliminated in the class A-B system.

In conclusion, summarizing the advantages of the system, we have an amplifier which will deliver either 18 or 36 W. with 5% harmonic distortion. The frequency response is flat with gain of 2 db. from 100 to 8,000 cycles. The overall gain is 80 db. The power consumption of the 18 W. amplifier is 100 W. and the power consumption of the 36 W. amplifier is only 150 W., therefore, either of these units can be operated economically in a sound truck. Despite the high gain of the voltage amplifier, the hum level has been kept low and microphonic noises eliminated. A two-position, four-circuit mixer is provided as an integral unit. The mechanical construction is exceedingly versatile, permitting

operation either as a rack-and-panel unit, or as a table mount unit. The amplifier provides for a change in power output requirements economically.

Notes on Construction and Operation

(1) The type 77 tubes should be connected as shown in the schematic diagram, Fig. 1. Referring to that diagram; the control-grid is adjacent to the cathode; the suppressor-grid is adjacent to the plate; the remaining grid is the screen-grid.

(2) Wiring may be point-to-point or cabled, as desired.

(3) Do not depend on connection to chassis for ground connection. Connect all units to be grounded to a common point which connects to the ground terminal on the cable plug or socket; and to the ground terminal on the terminal board.

(4) Any standard variable pad may be used (for attenuation). Insulate the shafts of the T-pad attenuators from the chassis.

(5) For minimum hum level the distance between the audio unit and the power unit should not be less than 7 ins.

(6) Operating voltages for the various tubes are tabulated below. These voltages should be maintained plus or minus 10% of the values given.

Type 77 tubes:

Plate Voltage—250 V. (no signal)

Screen-grid Voltage—75 V. (no signal)

Control-Grid Voltage—-3.3 V. (no signal)

Type 76 tubes:

Plate Voltage—250 V. (no signal)

Control-Grid Voltage—-13.5 V. (no signal)

Type 45 tubes:

Plate Voltage—300 V. (no signal)

Control-Grid Voltage—-64 V. (adjust R6 to this value.)

(7) When the amplifier is put into operation connect the ground terminal on the audio chassis to an external ground. Ground one side of the input line and ground one side of the output line.

Watch for the forthcoming issue of RADIO-CRAFT in which will be described the mixer system used in this 18-36 W. (at only 5% distortion) amplifier.

List of Parts

We shall be glad to furnish name of manufacturer on those items where not specified.

- One audio channel chassis;
- One power channel chassis;
- One voltage amplifier cradle suspension;
- One Cornell-Dubilier or Aerovox condenser, 16 mf., 450 V.;
- Two Cornell-Dubilier or Aerovox condensers, 8 mf., 450 V.;
- One Cornell-Dubilier or Aerovox condenser, 2 mf., 400 V.;
- Five Cornell-Dubilier or Aerovox condensers, 1 mf., 400 V.;
- Two Cornell-Dubilier or Aerovox condensers, .1-mf., 400 V.;
- Four 2-contact mixer sockets;
- Four 2-contact mixer plugs;
- Four 8 contact cable plugs and sockets;
- Two D.P.D.T. switches;
- One input class A prime transformer. Special for either two 45s, or four 45s;
- One tapped output transformer. Special for two or four 45s (see diagram);
- One filter choke, 10 hy., 200 ma., 100 ohms D.C. resistance;
- One filter choke, 30 hy., 90 ma., 350 ohms D.C. resistance;
- One power transformer (see Fig. 1);
- One tapped input push-pull transformer (see diagram);
- One impedance-resistance unit (see diagram);
- Two mixer dial plates;
- One motor plug cap and connector;
- Two special tube sockets, 6 prong;
- Eight tube sockets, 4 prong;
- Two tube sockets, 5 prong;
- Two tube shields;
- Seven resistors for audio channel (see diagram);
- One resistor for power channel, 25 W. (see diagram);
- One lettered terminal board;
- Two tube cover plates;
- One mixer cover plate;
- Ten rubber grommets;
- One coil of wire for power cable;
- One coil of wire for amplifier and power unit wiring;
- One coil of solder.

Please Say That You Saw It in RADIO-CRAFT

... new!



Burton-Webber

ALL WAVE

TEST OSCILLATOR

FULL VISION

DIRECT READING

\$29.50

47 inch scale. No confusing graphs or charts. Continuously variable range. 8 bands cover from 90 kilocycles to 25 megacycles. All on fundamental frequencies. Dial Standardized at 48 points with

Crystal Controlled Frequency Standards. Knife edge pointer with vernier drive. Licensed American Telephone & Telegraph circuit. High, Medium & Low steps afford perfect attenuation control throughout entire range. 400 cycle note, approximately 35% modulated, obtained by separate modulator tube. A. F. Signal available at panel jacks. One piece aluminum case prevents strays. Light weight, compact—carry it anywhere; battery operated—use it anywhere; A. C. or D. C. districts, auto radios, farm radios, etc.

BURTON • WEBBER

755 Boylston St.
Boston, Mass

Daily News Bldg.
Chicago, Ill.

BURTON-WEBBER

(Use address nearest you)

Gentlemen: Please send catalog No. 1745 on the Burton-Webber All Wave Test Oscillator.

Name.....

Address.....

City..... State.....

SEND FOR THIS

FREE CATALOG

100 pages chock full of BARGAINS in RADIO SETS, Long and Short Bargain Apparatus, Servicemen's Repair and Replacement Parts, Electrical Appliances and hundreds of miscellaneous specials at TREMENDOUS SAVINGS. Get this big new Bargain Book, It's absolutely FREE without obligation—just send us your Name and Address on a post card.

WRITE FOR YOUR COPY NOW.

JUST OFF THE PRESS

RADIO CIRCULAR CO., INC.
225 RC VARICK ST., NEW YORK

- - ahead of others in **TUBE TESTER** Value

INDIVIDUAL DIODE, TRIODE,
PENTODE TESTS

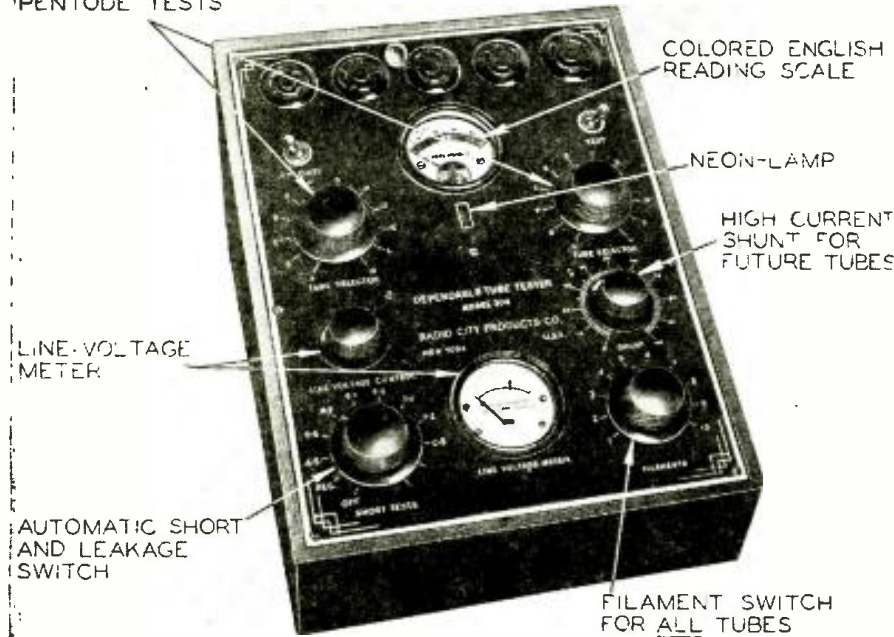

12 Outstanding Features!

- 1-ENGLISH READING Scale — COLORED DIAL indicates "GOOD-POOR-?"
- 2-TESTS EVERY TYPE of tube made to-day and many new ones which shall arrive in the future.
- 3-TESTS SHORTS and LEAKAGES between ANY TWO elements.
- 4-NEON LIGHT indicates leakages above 1,000,000 ohms.
- 5-SEPARATE LINE VOLTAGE meter with line voltage control.
- 6-INDIVIDUAL TESTS OF DIODE, triode, pentode, etc., sections of all combination-type tubes—both plates of all full-wave rectifiers.
- 7-PROVIDES AGAINST OBSOLESCENCE—Spare switching capacity for three times the present number of tubes.
- 8-SIMPLE TO OPERATE; convenient to use.
- 9-PROFESSIONAL APPEARANCE—etched panel; leatherette case.
- 10-ACCURATE D'Arsonval moving-coil meter, guaranteed 2% accuracy.
- 11-NO ADAPTERS of any kind necessary.
- 12-ECONOMY—Costs less than other testers that do not have all these features.

The new, Model 304, Dependable Tube Tester establishes a new "high" in test equipment to meet all modern requirements in testing. Simplicity in design and operation permit even the average consumer, who knows very little about radio technicalities, to follow the testing procedure, and to accept without further question the "good" or "bad" evaluation of every tube in the set.

Dependable Model 304—100-135 volts; 50-60 cycles
NET TO DEALERS **\$19.95**
(25 cycle—\$2.25 extra)



Combination Portable Carrying Case for Model 304
— illustrated — \$2.25 additional.

KIT FORM

In kit form — "to build your own" Model 304 Dependable Tube Tester — with all instructions. NET TO DEALERS... **\$15.65**

MODEL 304

Dependable Tube Tester also in Portable Model

There is an important economy factor in purchasing a Model 304 Dependable Tube Tester. The instrument is capable of making all essential tests, and, because it is portable, may be taken from store or laboratory and used on outside service calls. In addition it has a handy compartment for small tools.

2,000 OHMS PER VOLT MULTITESTER

A high-quality test instrument. The moving-coil instrument sensitivity is 2,000 ohms per volt. This instrument meets 4 major specifications. Ohm-meter range: ¼-ohm to 2 megs.; individual range: 0-2,000 (ohms)—0.2 (-meg.) -2 (megs.), (batteries, self-contained). Voltmeter range: 0-5-50-250-750 V. Milliammeter ranges: 0-50 ma. Microampere range: 0-500. The automatic selector switch connects the meter only to the desired circuit and range.



KNOCK-DOWN KIT—Model 303K
Complete with instructions (less batteries and case). NET TO DEALERS **\$10.95**

Net to Dealers .. **\$14.95**

WE ISSUE NO CATALOG
All orders are F. O. B. New York. Terms: A deposit of 20% is required with every order. Balance may be paid on delivery. Deduct 2% if full amount is sent.

GREN PARK COMPANY

101 Hudson St. Dept. RC New York, N. Y.

Please Say That You Saw It in RADIO-CRAFT

CLASSIFIED ADVERTISEMENTS

Advertisements in this section are inserted at the cost of twelve cents per word for each insertion—name, initials and address each count as one word. Cash should accompany all classified advertisements unless placed by a recognized advertising agency. No less than ten words are accepted. Advertising for the January, 1935, issue should be received not later than November 5.

A. C. GENERATOR

10 PRACTICAL AND LOW-COST CHANGES converting Dodge 12-V., Ford T. A., Chevrolet Delco 6-V. generators into 100-500 watt capacity A.C. generators, or into 32-110 V., D.C. motor or generator. Dodge is 500-W. self-exciter. All in one book illustrated with complete simplified instructions and drawings for only \$1. Autopower, 410 S. Hoyne Ave., Chicago.

ELECTRICAL SUPPLIES

INSULATION, WIRE, VARNISHES, SUPPLIES, etc. Send 3c stamp for bulletin. Autopower, 410 Hoyne Ave., Chicago.

PATENT ATTORNEYS

PATENTS—REASONABLE TERMS. BOOK and advice free. L. F. Randolph, Dept. 562, Washington, D.C.

PATENT INVENTIONS IS MY SPECIALTY through 28 years; Sterling Buck, Registered Patent Attorney 7780, 629 F, Washington, D. C. (Free Booklet-R).

RADIO

EXPERIMENTERS, SERVICEMEN—Chassis, shields, panels made to your specifications, prompt, reasonable. Aluminum chassis 10"x12"x13" high any drilling No. 3.00. Special! Analyzers for beginners in servicing make all tests low cost. Other analyzers complete or kits. We build almost anything. Send your specifications. CONSTRUCTORS SUPPLY, 303 Furman St., Schenectady, N. Y.

RADIO INSTRUCTION

RADIO ENGINEERING, BROADCASTING, aviation and police radio, Servicing, Marine and Morse Telegraphy taught thoroughly. All expenses low. Catalog free. Dodge's Institute, Pine St., Valparaiso, Indiana.

TRANSFORMERS

RADIO TRANSFORMERS, AUDIOS, chokes. Special transformers and windings. Write for catalog. Dealers wanted. Skiles Transformer Co., California Ave., Fort Wayne, Indiana.

SHORT-WAVE SET BUILDERS NEED THIS BOOK

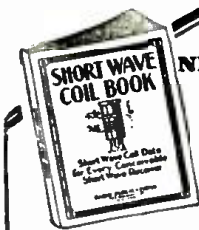

Every experimenter who has ever tried to build a short wave set knows by experience, the difference between a good and a poor receiver is usually found in the short wave coils. Often you have sought through magazines, books, etc., to find the information you require. The present book has been gotten up to obviate those difficulties. In this book you find every possible bit of information on coil winding. Only the most modern "dope" has been published.

Illustrations galore, giving not only full instructions on how to wind coils, but dimensions, sizes of wire, curves, how to plot them, by means of which any coil for any particular short wave set can be figured in advance, as to number of turns, size of wire, spacing, etc. There has never been such data published in such an easy accessible form as this.

Send your remittance of 25c in cash or unused U.S. postage stamps for four copies of the SHORT WAVE COIL BOOK. Sent to you prepaid. RADIOD PUBLICATIONS, 101C Hudson St., New York, N.Y.

SEXOLOGY

THE MAGAZINE OF SEX SCIENCE

SEXOLOGY, foremost educational sex magazine, is written in simple language and can be read by every member of the family. It is instructive, enlightening—not a risqué book—contains no offensive matter.

Contains 25 important articles on Sex Science, 68 pages, with attractive two-color cover. Here are a few of the more important articles:

- "Sex Appetite"—Women's Strike Against Childbirth (Illustrated)—Sex Nervousness in Men (Illustrated)—Hygiene of Menstruation (Illustrated)—Should I Be Cystoscoped? (Illustrated)—Science Turns Girl Into Boy (Illustrated)—Mechanics of Childbirth (Illustrated)—Circumcision Among Savage Peoples (Illustrated)—Examination of the Semen (Illustrated)—Thyroid Gland and Pregnancy—Sex Education Before Marriage (Illustrated)—Unusual Forms of Sex (Illustrated)—Predetermination of Sex (Illustrated)—A New Theory of Homosexuality (Illustrated)—Sex and Punishment (Part II) (Illustrated)—Scientific Sex Notes—Questions and Answers—Book Review.

Get a copy of SEXOLOGY on any newstand, or if your dealer cannot supply you, send 25c cash or stamps for current issue.

SEXOLOGY, 55R Hudson St., NEW YORK, N. Y.

INTERNATIONAL RADIO REVIEW

(Continued from page 333)

VISUAL-TUNING TRANSFORMER

THE IDEA of varying the magnetic flux in a transformer core to correspond with variations in carrier strength as a station is tuned to resonance is not new (the subject has been discussed in RADIO-CRAFT—a complete Data Sheet diagram has appeared, showing the application of such a device), but the adapter described in the September 14th issue of WIRELESS WORLD is new.

The method of connecting the unit into the plate circuit of a variable-mu amplifier tube is shown at A in Fig. 2; an interior view of the device appears at B in this figure.

The impedance of the secondary of transformer T depends upon its inductance which, in turn, is a function of the degree of magnetization of its iron core. In Fig. 2A leads "X" of the transformer unit connect to the A.C. filament supply that also supplies the heaters of the tubes in the set. The pilot light marked "2 V lamp," then, should have a terminal voltage rating one-half that of the set's filament supply voltage (The "Single-Span" receiver from which this circuit was taken operates on a filament voltage of 4 V.). The next step is to adjust resistor R until with "no signal" and the plate-circuit winding of transformer T connected into circuit as shown, the pilot light barely glows. Now, a strong station carrier at resonance will greatly increase the brilliancy of the pilot bulb, which may be used as a dial light.

Choke Ch. and condenser C serve to filter the hum voltage which otherwise would be coupled, via unit T, from the filament circuit to the plate supply.

STATEMENT OF THE OWNERSHIP, MANAGEMENT, CIRCULATION, ETC., REQUIRED BY THE ACT OF CONGRESS OF MARCH 3, 1933

Of RADIO-CRAFT, published monthly at Mt. Morris, Ill., for October 1st, 1934.
State of New York ss.
County of New York ss.

Before me, a Notary Public in and for the State and county aforesaid, personally appeared Irving S. Manheimer, who, having been duly sworn according to law, deposed and says that he is the business manager of RADIO-CRAFT and that the following is, to the best of his knowledge and belief, a true statement of the ownership, management (and if a daily paper, the circulation), etc., of the aforesaid publication for the date shown in the above caption, required by the Act of August 21, 1912, embodied in section 411, Postal Laws and Regulations, printed on the reverse of this form, to wit:

1. That the names and addresses of the publisher, editor, managing editor, and business managers are:
Publisher, Continental Publications, Inc., 401 North Wesley Ave., Mt. Morris, Ill.
Editor, Hugo Gernsback, 99 Hudson Street, New York, N. Y.
Managing Editor, Jos. T. Bernstein, 99 Hudson Street, New York, N. Y.

Business Manager, Irving S. Manheimer, 99 Hudson Street, New York, N. Y.

2. That the owner is: (If owned by a corporation, its name and address must be stated and also immediately thereunder the names and addresses of stockholders owning or holding one per cent or more of total amount of stock. If not owned by a corporation, the names and addresses of the individual owners must be given. If owned by a firm, company, or other unincorporated concern, its name and address, as well as those of each individual member, must be given.) Continental Publications, Inc., 99 Hudson Street, New York, N. Y., and all the stock of Continental Publications, Inc., is owned by Gernsback Publications, Inc., 99 Hudson Street, New York, N. Y., and that stockholders of Gernsback Publications, Inc., owning more than 1% of the stock are: Hugo Gernsback, 99 Hudson Street, New York, N. Y.; Irving S. Manheimer, 99 Hudson Street, New York, N. Y.

3. That the known bondholders, mortgagees, and other security holders owning or holding 1 per cent or more of total amount of bonds, mortgages, or other securities are: (If there are none, so state.) None.

4. That the two paragraphs next above, giving the names of the owners, stockholders, and security holders, if any, contain not only the list of stockholders and security holders as they appear upon the books of the company but also, in cases where the stockholder or security holder appears upon the books of the company as trustee or in any other fiduciary relation, the name of the person or corporation for whom such trustee is acting, is given; also that the said two paragraphs contain statement embracing affiant's full knowledge and belief as to the circumstances and conditions under which the stockholders and security holders who do not appear upon the books of the company as trustees, hold stock and securities in a capacity other than that of a bona fide owner; and this affiant has no reason to believe that any other person, association, or corporation has any interest direct or indirect in the said stock, bonds, or other securities than as so stated by him.

IRVING S. MANHEIMER.

Sworn to and subscribed before me this 25th day of September, 1934.

[SEAL] MAURICE COYNE.
(My commission expires March 30, 1936.)

Please Say That You Saw It in RADIO-CRAFT



One Out of Every Four SERVICEMEN WILL FAIL THIS YEAR!

It is estimated that at least 25% of all servicemen fail or go out of business every year. Today this percentage may be even higher. Increased competition plus a demand for quality work from customers who have more money to spend will see to that. More than ever, towards are going to the man who KNOWS HOW!

And that is one of the reasons why registrations are now pouring in for Sprayberry's Practical Mechanics of Radio Service—an inexpensive 28-lesson post-graduate course for those already in the service business. . . . I don't claim to help you get rich quick. However, I DO show how to handle all types of service work in the BEST MOST PRACTICAL way—how to modernize all equipment—how to get the "jump" on competition. No "fluff" or fancy bindings. Just a sound, how-to-do-it course that will prove of untold practical value—and sold at a price you can well afford to pay!

The enclosed coupon will bring full details of an opportunity which you owe to your business future to investigate.

FREE So that you can judge PRACTICAL MECHANICS for yourself, I'll gladly send any one of the following lessons. Check the one you prefer:

- Lesson No. 27—Commercial Analyzers and How to Modernize Old Ones.
- Lesson No. 8—Repairing AVC Circuits.
- Lesson No. 2—Set Testing by Voltage Methods.

Get These NEW DATA SHEETS at No Extra Cost

Sprayberry Data Sheets need no introduction to thousands who have built new jobs, new profits through them. Now comes a NEW SERVICE telling exactly how to modernize 16 old analyzers for 6-c. 5-prong tubes, etc., 11 popular receivers for new tubes, A.V.C., etc., etc. Sold for \$3 or given to my students at no extra cost.

F.L. SPRAYBERRY 2548 University Pl., N.W., WASHINGTON, D.C.

Please send full details of your course, also the one free lesson I have indicated.

Name _____
Complete Address _____

SPRAYBERRY'S PRACTICAL MECHANICS OF RADIO SERVICE
"DUCO" Condensers
GUARANTEED ONE YEAR ★ FREE REPLACEMENTS

TUBULAR BY-PASS				
CAP. MFD.	D.C. VOLTS	NET PRICE	NET PRICE	
.001	600	6c	400 .08	
.002	600		600 .08	
.006	600		200 .09	
.01	600		400 .12	
.02	600		500 .15	
.05	200		200 .15	
.05	400		400 .18	
.1	200		600 .20	
CARDBOARD ELECTROLYTIC				
CAP. MFD.	D.C. VOLTS		PRICE	PRICE
2	4-4	.27	.48	
4	4-8	.31	.49	
6	6-6	.33	.52	
8	8-8	.39	.60	
10	8-8	.45	.90	

PAPER CONDENSER			
CAP. MFD.	PRICE	PRICE	PRICE
400 v.	600 v.	1000 v.	
1	.15	.19	.50
.25	.22	.25	.60
.5	.29	.35	.65
1	.40	.50	.70
2	.62	.71	1.00
4	.84	1.45	2.00

We prepay shipping charges on all orders of \$5.00 or more if remittance is sent in full. All orders are otherwise sent C.O.D. Remit 10% with order, balance on delivery. Orders are f.o.b. New York City.

Write for Bulletin No. 5 listing other bargains!
G. & E. SALES CO. 303 Fourth Ave., New York, N. Y.

BARGAINS

All Merchandise Offered On Page Is Absolutely New And Unused

Electrical Portable Sprayer Outfit

\$27⁵⁰
COMPLETE

Formerly sold for \$68.50

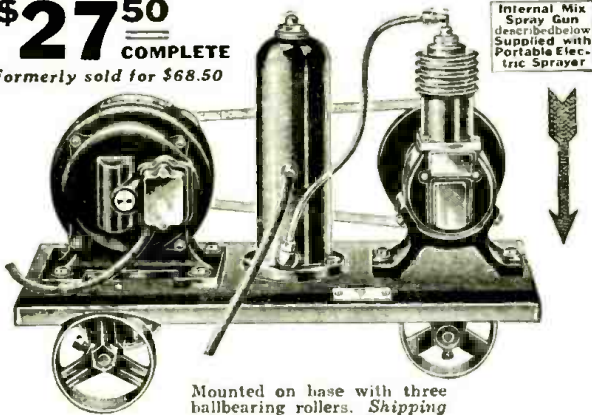

Mounted on base with three ballbearing rollers. Shipping weight of complete outfit, 55 lbs.

This is the ideal outfit for all-around spraying work wherever current is available. With this electric sprayer you can spray paint, varnish, duco, enamel, lacquer, insecticides, etc., with speed. You can move it from one room to another with ease. Simply insert plug into electric socket and this marvelous machine is ready to do a man-size job—and do it efficiently.

This electric portable sprayer saves its cost over and over again on your own work. It will make money for you doing jobs for others.

Outfit equipped complete with Internal Mix Spray Gun, with quart aluminum cup, which enables you to obtain round or fan spray, 1/4 H.P. heavy duty motor, 110-volt, 60-cycle AC, air filter, safety valve, Kellogg Air-Cooled Compressor, 1 1/2 x 1 1/2, 15 feet of hose, cord and plug.

Price of complete outfit with gun, \$27.50
Price of outfit without motor, \$20.00

Internal Mix Spray Gun

This Pressure Type Internal Mix Spray Gun is the Finest Value on the Market. It Embodies the Seven Following Outstanding Features

1. Hardened steel paint valve needle and nozzles, to resist the cutting action of abrasives in paint.
2. Quart capacity aluminum cup with concave bottom to resist high pressures—very light and durable.
3. Air control (shown on top of gun, just back of the nozzle) gives instantaneous control over the "wetness" of spray.
4. Positive material control (shown at back of gun, above handle).
5. New type construction of cup cover allows instant removal for cleaning or for attaching a paint hose to the gun.
6. Latest type handle—"fits the hand."
7. Two-finger trigger.

In this gun the material is forced up to the nozzle under pressure, properly mixed within the nozzle and discharged, perfectly atomized, in a fan-shaped spray 6 to 12 inches wide. One hardened steel nozzle for round spray also furnished with gun.



Shipping \$7⁵⁰
Wt. 3 lbs.

Filter Tank \$4²⁵

Complete with tank, gauge and 60 lb. safety valve

Compressed air filter and expansion tank, equipped with gauge and safety valve. Has standard taps in tank and base ready to install. Eliminates oil and moisture.

Same as illustrated in Electric Portable Sprayer Outfit shown above.
Shipping weight 8 lbs.

Kellogg Air-Cooled Compressors

Same as illustrated in Electric Portable Sprayer Outfit shown above.

Size	Maximum Pressure	Speed	Motor Required	Price
1 3/4 x 1 1/4	75 lbs.	600	1/4 H.P.	\$7.50
1 1/2 x 2	100 lbs.	600	1/2 H.P.	9.00
2 x 2	125 lbs.	600	1/3 H.P.	10.50
2 1/4 x 2	175 lbs.	500	1/3 H.P.	12.50

Shipping weight, 12, 13, 14, and 18 lbs.

G. E. MOTORS

These Motors were manufactured by the General Electric Company and originally intended for use by a large manufacturing company.

Here are the specifications: 1/30 h.p.—1800 R.P.M. Universal A.C. and D.C. 110 volts instant reverse. Size: Diameter 3", length overall 4". Diameter of shaft 1/2". Add 25c for special packing and mailing anywhere in U.S.A. Ship. Wght. 3 lbs.

\$245
EACH

WHILE THEY LAST.

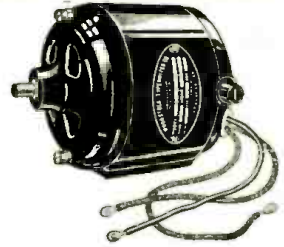

Original Price \$12.00

HEAVY DUTY Electric Drill 3/8 in.

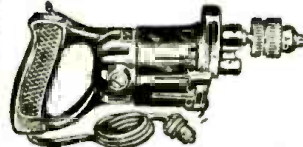

\$14⁹⁵

Shipping weight, 7 lbs.

WEIGHT—6 pounds, perfect balance.
CAPACITY—3/8 inch.
MOTOR—Westinghouse Universal, specially constructed for this drill, 110 volts, DC, or 60 cycle, AC.
BODY—Aluminum
FREE SPEED—2,000 revolutions per minute. Full load speed, 850 R.P.M.
GEAR REDUCTION—7 1/2 to 1.
BUSHINGS—Special high-grade bronze.
GEARS—Nickel alloy steel and high-grade bronze.

VENTILATION—Forced, around field and armature.
SWITCH—Normally open, quick break. Designed for this drill. Approved by Underwriters.
CHUCK—3/4 inch—keyless.
LENGTH—Over all, 12 inches. All parts interchangeable.
Equipment complete with chuck, 7-foot rubber-covered cord and steel-armored, unbreakable attachment plug.

Westinghouse Power Generator

Manufactured by Westinghouse for U. S. Signal Corps.

Built-in commutator takes off the generated D.C.

Three leads extend through the casing to permit a 4 1/2 V. flashlight-type battery to be switched into circuit for starting, and to control the A.C. output. Rotated at its normal speed of 4,500 R.P.M., the output is 200 W., at 115 to 125 V. (on open circuit), 900 cycles. The rotor turns in ball bearings. Shaft length (driving end), 2 ins.; diameter 9/16-in.; the end is threaded for a distance of 3/8 in. Base dimensions exclusive of the shaft, 4 1/2 x 6 1/2 in. in diameter. Guaranteed new and perfect.

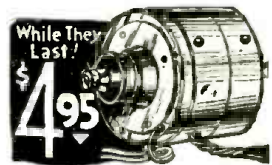

Shipping weight, 13 lbs.

Here is what one of our customers writes:

"These generators are being used in a small fishing village, where the only current is supplied from a 2K.W.-D.C. generator.

"As it was impossible to use A.C. sets and especially my short wave transmitter using two 45 tubes, one of the generators is used to supply my two A.C. receivers and the other to supply power for the transmitter. Both generators are run by a 1/2-horsepower motor. These generators perform perfectly and have been absolutely trouble free. The voltage and current regulation is remarkably stable, taking a considerable overload."—(Name supplied on request.)

G. E. Phonograph Motor

Variable speed induction type self-starting, 110 volt, 60 cycle AC (also furnished in 50 and 25 cycles at same price) with lever control. Speed range from 5 to 200 R.P.M. Can be installed in place of old-fashioned, hand-winding speed motor. Also ideal for display turn table, and a hundred other uses. These G.E. Electric Motors are brand new, in original factory cartons.

Complete with speed regulator (not shown in above picture). **\$395**

When ordering state if 60, 50, or 25 cycles.

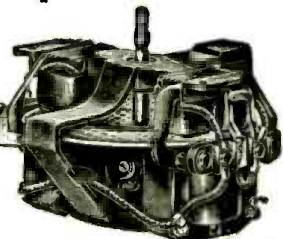

Formerly Sold for \$15.00
Shipping weight, 11 lbs.

WELLWORTH TRADING CO.
560 West Washington St., Chicago, Ill.

RC-1234

I enclose \$..... for which please send me the following:

.....
.....

Name

Address..... City..... State.....

ORDER FROM THIS PAGE

Since We Do Not Publish Any Catalog

Remit by check or money order for full amount of each item—shipped by express collect, if no money for P.P. enclosed. No C.O.D. order accepted. Money refunded if not satisfied. Be sure to state shipping point if express or freight office is not in your town.

WELLWORTH TRADING CO.

560 West Washington St.

Chicago, Ill.

● Index to Advertisers ●

A	
Alan Radio Corp.	362
Allied Radio Corp.	370
Anperite Corporation	371
B	
Baltimore Radio Corp.	360
Belden Mfg. Company	362
Bud Speaker Company	372
Burgess Battery Co.	357
C	
Capitol Radio Engineering Institute	368
Capitol Radio Research Laboratories	367
Central Radio Laboratories	360
Classified Section	341
Coast-to-Coast Radio Corp.	377
Columbia Sound System Co.	373
Continental Carbon, Inc.	376
Cornell-Dubilier Corp.	362, 374
Coyne Electrical School	321
Crowe Nameplate & Mfg. Co.	362
D	
Tohe Deutschmann Corp.	363, 364, 368
Delta Radio Company	374
E	
Eilen Radio Laboratories	364
Electrad, Inc.	359, 362
F	
Fox Sound Equipment Corp.	365
Franklin Transformer Mfg. Co.	377
Freed Radio Company	367
Freed Radio & Television Co.	366
G	
G & E Sales Company	381
General Transformer Corp.	373
Goldentone Radio Company	364
Grenpark Company	380
H	
Hammarlund Mfg. Company	362, 371
Hukrade-Sylvania Corp.	363
I	
Insuline Corp. of America	358
K	
Kay Specialty Mfg. Co.	371
L	
L & L Electric Company	367
Leotone Radio Company	364
Arthur H. Lynch, Inc.	383
M	
McGraw-Hill Book Company	364
Matthew's Radio	364
Meissner Mfg. Co.	362
Midwest Radio Corp.	Back Cover
N	
National Radio Institute	323
National Union Radio Corp.	369
O	
Ohmite Mfg. Co.	362
P	
Pioneer Gen-E-Motor Corp.	374
Pioneer Sound Labs.	371
Popular Medicine	383
Postal Radio Corp.	363
R	
Radio & Electric Service Co.	362
Radio Circular Company	379
Radio City Products Co.	369
Radio Equipment Corp.	376
Radio Publications	381
Radio Trading Company	384
Radio Training Association	372
Radolek Company	383
RCA Institutes, Inc.	376
RCA-Victor Company	Inside front cover
Readrite Meter Works	375
S	
S. O. S. Corporation	364
Sexology Magazine	381
Shallcross Mfg. Co.	370
Shure Brothers Co.	367
Solar Mfg. Corp.	372
F. I. Sprayberry School	381
Supreme Instruments Corp.	367
T	
Thordarson Elec. Mfg. Co.	362
Triplett Elec. Instrument Co.	361
Try-Mo Radio Co., Inc.	363
The Turner Company	373
U	
Universal Microphone Co.	371
W	
Burton-Webber Company	379
Webster Company	377
Wellworth Trading Co.	382
Wholesale Radio Service Co., Inc.	365
F. A. Wilcox	364
Wright-DeCoster, Inc.	366

(While every precaution is taken to insure accuracy, we cannot guarantee against the possibility of an occasional change or omission in the preparation of this index.)

INFORMATION BUREAU

(Continued from page 373)

to read in the order of 25 or 50 W. Of course, the watt meter must also be able to handle without excess heating about 6 amperes of current.

Some users of these condensers rate them in terms of the current they pass, and the accompanying chart shows the relation between the current and the capacity of the condenser. Therefore, if a condenser is required which will pass, say 5 amperes at 110 V., the capacity can be determined from this chart and will be found to be 121 mf. for this particular case.

The chart in Fig. Q298C shows graphically the relation between the capacity, the wattage loss corresponding to 10% power factor, and the current in amperes. The several curves indicate these various values at 100 V., 110 V., 150 V., and 220 V. 60 cycles. The curves are plotted on a basis of 10% power factor since this is the minimum guaranteed power factor, although, in general, a starting condenser will have a power factor in the order of 5%. Obviously if a testing circuit is set up and the wattage of the condenser is say 25, and the wattage for 10% power factor is 50 then the condenser has a power factor of 1/2 of 10% or 5%. In other words, it is simply necessary to determine the 10% wattage from the curve, and the actual wattage, and then the actual power factor bears the same relation to 10% as does the actual wattage to the wattage read from the curve.

This chart also indicates the essential circuit diagram for such a test set up. As indicated, the required units are a tapped transformer, ammeter, wattmeter and voltmeter."

"CONVERTING OLD SETS"—A.K. 67, 67C"

(299) Mr. Arthur Kenway, Salisbury, Md. (Q.) In the article, "Converting Old Sets," by Gordon E. Lockerd, in the October issue of RADIO-CRAFT, mention is made of a Fig. 2. This was under the description of converting an A.K. 67, 67C receiver to 2 V. operation.

Also in the same issue, same article, for improving an Echophone model C receiver, reference was made to a Fig. 3.

I looked all through this article but could not find the illustration referred to. This was probably an oversight, and I am wondering whether corrections have appeared since or if you can furnish me with these diagrams inasmuch as I am interested in obtaining this information. While I have no immediate use for it I am compiling a complete file on converting set data and should like to have the aforementioned illustrations very much.

(A.) Figure 3 which was omitted in the article you refer to was published on page 310 of the November issue of RADIO-CRAFT. Fig. 2 on 2 V. operation of the A.K. 67, 67C receiver is given in Fig. Q299. It pertains to the voltage divider circuit employed; volume control circuit which regulates volume by changing the bias on the R.F. tubes; and a method for improving the "C" biasing arrangement and thereby eliminating distortion.

RADIO-CRAFT INDEX

By Subjects, Issues and Authors, the July 1929 to June 1932 issues of RADIO-CRAFT are indexed and cross-indexed, in a publication you may obtain for only 25c (stamps or cash). Write to us for this valuable 24 page reference; its use will save you time and money!

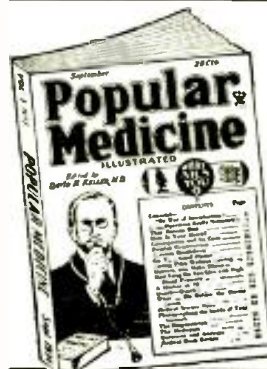

KNOW THYSELF!

This new monthly magazine is also your own doctor. WHAT AILS YOU? POPULAR MEDICINE tells and advises you thoroughly. Written for you by doctors. Non-technical yet authoritative for all laymen. Many anatomical illustrations. At all newsstands

Special Offer! 8 Months for \$1

Send 25c for sample copy POPULAR MEDICINE 97R Hudson St., New York, N. Y.

Know What You Are Buying

● Radolek's 1935 Radio Profit Guide accurately describes every piece of merchandise required in Radio Service.

● Radolek's Engineering Staff examines every new item! These technicians write the descriptions published in the Radolek Profit Guide. When you choose merchandise from this big catalog, you are assured of reading an accurate description of what the item consists and what purpose it serves!

● Lowest Prices! Our Engineers compare Radolek's merchandise with competition. Our prices are determined by comparative quality and are equal to or lower than prices on any similar quality items offered by other distributors of fresh, new merchandise. Whenever market prices are reduced, you will always receive the benefit of these new lower prices.

● Radolek protects your interests by restricting distribution of the Radolek Profit Guide to active and legitimate Radio accounts. Full co-operation is extended to Radio Dealers and Service Associations to restrict wholesale prices to the Trade only.

● Secure Greater Radio Profits! Send for your copy of the 1935 Radio Profit Guide! Use your letterhead or card.

The Radolek Co.
609 West Randolph Street
Chicago, Illinois

LYNCH HI-FI

(High Fidelity)

ANTENNA SYSTEMS

Guaranteed to improve reception with any receiver, in any location.

LYNCH "HI-FI" aeriels are necessary with the new High-Fidelity receivers.

There are LYNCH "HI-FI" antenna kits for every purse and purpose. They're easy to install and they work like nobody's business.

From \$3.50 to \$7.90, list

Full Information on Request

ARTHUR H. LYNCH, Inc.

227 Fulton St., New York, N. Y.

If you are interested in servicing electric refrigerators, write Gernsback Publications, Inc., 99 Hudson St., New York, N. Y., for circulars on the Official Refrigerator Service Manual.

★ ★ ★ ★ ★ RTC-BARGAINS!



BIG 8-TUBE CONSOLE CHASSIS

Complete With 11-inch Dynamic Speaker
AIRPLANE DIAL :: TONE CONTROL

"THE GREATEST SET BUY IN AMERICA" is by all means a mild description of the value which we are offering here. This very same 8-tube receiver as recent as eight months ago, sold for more than \$95.00, yet now, because of the advent of even later type tubes, you can purchase this receiver for only a small fraction of that price. The tubes employed in this set are still comparatively new, and not only that, but all modern features such as 2A5 parallel output, tone control, phonograph attachment provisions, full dynamic speaker, airplane dial, etc., are incorporated.

ONLY \$15.95 WHILE THEY LAST

Not a Midget!
but a full-sized CONSOLE CHASSIS

The selectivity and sensitivity of this 8-tube receiver, due to its 4 tuned stages, are just as sharp as those of an 11-tube superheterodyne. The construction of the set is best described as "standard," for its circuit is more other than the "good old stand-by" T.R.F. type modified and improved to use these later type tubes.

The supply of these large console chassis is limited. The moral is, "Don't delay, order today." Overall size of chassis, 15 1/2" x 11" x 8 1/2". Shipping weight, 40 lbs.
List Price \$95.00
No. 2000N—8-Tube T.R.F. Receiver, Including Dynamic Speaker But Less Tubes
TUBES: 3 58's, 2 56's, 2 2A5's, 1 80 \$6.30

LIMITED QUANTITIES

REMOTE CONTROL Attachment

Complete Nothing Else to Buy

This remote control unit was made by the Tish Company for some of the popular receivers which sold for more than \$300.00. Yet, you or anyone else without the use of tools can attach it to your own radio in less than a half-hour's time.

You can then hide the radio in a closed basement, or some other out-of-the-way place and located in various parts of your apartment, or strategically the surplus of your family or guests at dinner, when by merely turning a switch on a beautiful etched metal plate, the room is instantly flooded with beautiful music or other entertaining program.

EXTREMELY SIMPLE TO OPERATE

This instrument has no rotating motor gears or other elaborate machinery to fear out of order. In order to connect it to your radio, you need but connect it to the tuning condenser. That's all! The mechanical work required! Then you merely connect the volume control wires. No. 358 Utah Remote Control Attachment, YOUR PRICE, ONLY \$4.95

STRETCH YOUR DOLLAR

By **BUYING FROM US**

FLASH

ACT FAST ORDER TO-DAY

READRITE TUBE CHECKER

Designed to quickly and accurately test all tubes, and incorporated two instruments having shaded two-color scale (100%) directly on a tube. The other is used with A.C. meter rheostat for testing the line voltage selector switch to show repairs to the required parts. Chart furnished. Limited shipping weight 1/2 lb. List Price \$40.00. YOUR PRICE \$23.52

Model 422
Cathode and grid shorts. These shorts are the slightest short or leakage. Two different tubes and sizes. No. 421 counter type. Approx. \$23.52

Portable Model
Includes leather handle, with sub-stantial fasteners on sides of case. Size 11" x 6 1/2" x 7". Weight approximately 1 1/2 lbs. (as shown) Portable. List Price \$24.99. YOUR PRICE \$23.52

TERMS

Send money order, certified check or new U.S. stamps. C.O.D. shipments only if 20% remittance accompanies order. If sent via parcel post include charges; excess refunded.

THINK OF IT!

Sound movies - - - Electric recordings

More than \$350 worth of entertainment for only \$82.95. That's value without precedent. Synchronized talking movies—Modern electric phonograph—

Radio entertainment

--- all in your own home!

graph—Large 8-tube console radio and dynamic speaker—all this we offer you in a single full-sized genuine walnut cabinet for only \$82.95.

NEW!

Readrite Model 720 Analyzer
Flexible Point-to-Point Tester

Tests ALL Latest Type Tube Circuits

Requires minimum manipulation, is extremely flexible and so arranged that voltage and current can be measured in any tube circuit. Resistances, capacitances and capacities are also quickly measured.

Point-to-point tests are made through an 8 conductor cable and plug connected to the set socket.

Has one AC and one DC meter. Rugged, simple, steady and accurate in use. The DC scales are 15, 150, 300 and 600 volts, 15 and 150 milliamperes. The AC scales are 10, 25, 100 and 750 volts. Ship. wt. 11 lbs.

No. 720 Readrite Point-to-Point Set Analyzer.
YOUR PRICE \$14.70

WORTH \$350.00

20 WATTS

Class "B" Amplifier Kit

Here is a splendid opportunity to buy a real, professional amplifier at a substantial saving! There are only 20 of these kits available at this price. First come, first served! No. 46K 20-Watt Amplifier Kit.

FREE!

Radio and Short Wave Treatise

108 Pages
1500 illus.

Enclose five cents (coin) for postage. Treatise sent by return mail. Print name and address clearly on request.

Completely revised and enlarged, this new 1935 edition contains 108 solid pages of useful radio information, diagrams, illustrations, radio links and real live radio merchandise.

PARTIAL LIST OF CONTENTS: Fundamental Principles of Radio for the Beginner, Chapter 2—Fundamental Circuits and Uses of New Tubes—Revamping Six-Volt Battery Sets for Two-Volt Tubes—Public Address Systems—How to Build Short-Wave Transmitters and Receivers—Up-to-Date Tube Chart and Socket Connections, etc., etc.

WRITE TO-DAY

Radio Trading Co., 97 Hudson St., New York City

Please Say That You Saw It in RADIO-CRAFT

NOW READY

Official Air Conditioning Service Manual

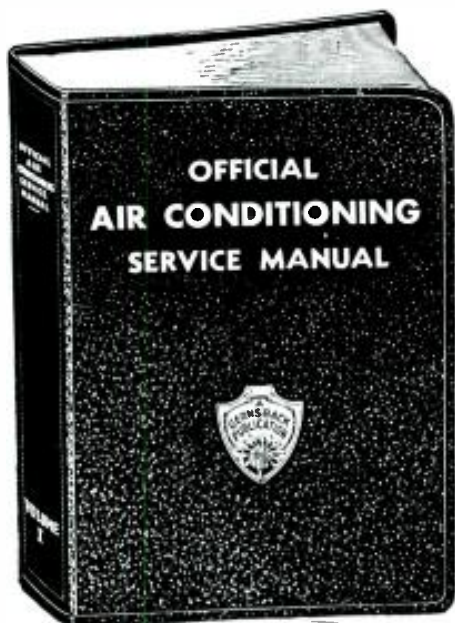

NOW
\$5.00
A COPY

352 Pages
Over 600 Illustrations
9" x 12" in Size
Flexible, Loose Leaf
Leatherette Cover



A GOLDEN OPPORTUNITY FOR ALERT MEN IN THE NEXT GREAT INDUSTRY

THE idea of electricians, radio service men and other mechanically inclined men servicing Air Conditioning and Refrigeration Units is self-evident and the thought has occurred to some untold thousands ever since air conditioning equipment has been installed in public auditoriums, theatres, studios, department stores, office buildings and manufacturing plants. The tremendously broad possibilities in this new industry are bound to give employment and success to men far-sighted enough to see its advancement and development. We quote an excerpt from Mr. Hugo Gernsback's editorial which appeared in a recent issue of *Everyday Science and Mechanics*:

"I advise young and progressive men to go into the air-conditioning business during the next few years; because this, without a doubt, is the coming industry in this country. Thousands of small firms will spring up, undertaking to air-condition private houses, small business offices, factories, etc. We are not going to tear down every building in the United States immediately. It will be a gradual growth; yet small installation firms will air-condition small houses, and even single offices in small buildings."

This is only partial proof of the certain success of this new field. Further assurance is that engineering schools have already added many important courses on air conditioning to their regular curriculum. Architects and building contractors are giving considerable thought to installation of this equipment in structures which are now being planned and built. The beginning of this business will probably be similar to the auto and radio industry, but in a few short years it will surpass these two great fields.

The **OFFICIAL AIR CONDITIONING SERVICE MANUAL** is edited by L. K. Wright, an expert and a leading authority on air conditioning and refrigeration. He is a member of the American Society of Refrigerating Engineers, American Society of Mechanical Engineers, National Association of Practical Refrigerating Engineers; also author of the **OFFICIAL REFRIGERATION SERVICE MANUAL** and other volumes.

In this Air Conditioning Service Manual nearly every page is illustrated; every modern installation and individual part carefully explained; diagrams furnished of all known equipment; special care given to the servicing and installation end. The tools needed are illustrated and explained; there are plenty of charts and page after page of service data.

Remember there is a big opportunity in this new field and plenty of money to be made in the servicing end. There are thousands of firms selling installations and parts every day and this equipment must be cared for frequently. Eventually air conditioning systems will be as common as radios and refrigerators in homes, offices and industrial plants. Why not start now—**increase your earnings with a full- or spare-time service business.**

Here are some of the chapter heads of the **AIR CONDITIONING SERVICE MANUAL**:

CONTENTS IN BRIEF

History of Air Conditioning; Fundamental Laws; Methods of Refrigeration; Ejector System of Refrigeration; Compression System of Refrigeration; Refrigerants; Lubricating Oils; Liquid Throttle Devices; Servicing Expansion and Float Valves; Servicing Refrigerating Systems; Control Devices; Thermodynamics of Air Conditioning; Weather in the United States; The Field of Air Conditioning; Insulating Materials; Heat Transmission Through Walls; Complete Air Conditioning Systems; Estimating Requirements for the Home, Small Store, Restaurant; Layout of Duct Systems; Starting Up a System; Operating and Servicing Air Conditioning Systems; Air Filtration, Ventilating and Noise Eliminating Devices; Portable Electric Humidifiers and Room Coolers; Automatic Humidifiers; Air Conditioning Units for Radiator Systems and Warm Air Systems; Central Conditioning Units, etc.

GERNSBACK PUBLICATIONS, INC.

99 Hudson Street

New York, N. Y.

MAIL COUPON TODAY!

GERNSBACK PUBLICATIONS Dept. RC-1234
99 Hudson Street, New York, N. Y.

Gentlemen: Enclosed you will find my remittance of Five Dollars for which you are to send me One Copy of the **OFFICIAL AIR CONDITIONING SERVICE MANUAL, POSTAGE PREPAID.**

Name

Address

City State

(Send remittance in form of check, money order or unused U. S. Postage Stamps. Register letter if it contains stamps or currency.)

SAVE up to 50% by BUYING DIRECT

from LABORATORIES

Thousands Thrill to **GUARANTEED**
World-Wide **HIGH FIDELITY**
Performance
with this—

Amazing
New
MIDWEST

**1935
SUPER**

16-TUBE
ALL-WAVE Radio
(ALL FIVE WAVE BANDS)

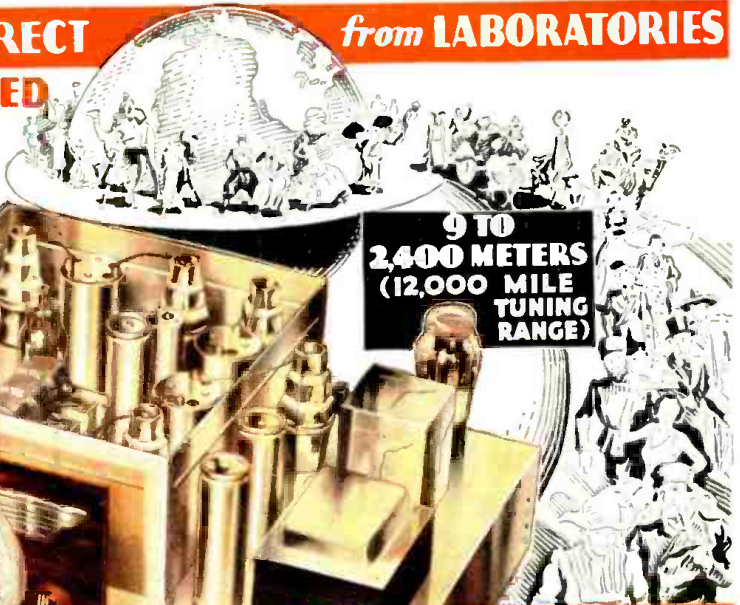

9 TO
2,400 METERS
(12,000 MILE
TUNING
RANGE)

**WORLD'S GREATEST
RADIO VALUE**

\$57.50
with
New
**Deluxe Auditorium-Type
SPEAKER**

... LESS TUBES ...

TERMS AS LOW AS \$5.00 DOWN

**30
DAYS
FREE
TRIAL**

**OVER 110,000 SATISFIED
CUSTOMERS SAVED 1/3
TO 1/2 BY BUYING DIRECT**

World-Wide Entertainment



Springfield, Ill.—I investigated all makes of radios, and I chose the Midwest. No radio made can equal it. I logged with ease and good volume: LSX, LSN, HLABH, HLABD, YVIBC—VK2ME, Australia—GSC, GSB, GSA, Eng.—DJA, DJC, Ger.—FAQ, Spain, etc. W. C. Gaiser, 2260 Yale Blvd.

Admires Wonderful Tone

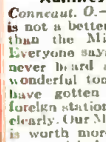

Connecticut, O.—There is not a better radio than the Midwest. Everyone says they never heard such a wonderful tone. We have gotten many foreign stations very clearly. Our Midwest is worth more than we paid for it. Mrs. M. C. Mondly, 179 Marshall St.

Gets Byrd at Pole Direct



Hammond, La.—The greatest distance I have received so far is Byrd at the Pole direct, not a relay through LSX, EAQ and VK2ME come clearly as locals. DJB GSC, GSB, come in extremely well. R. T. Parsley.

BEFORE you buy any radio write for the new FREE 1935 Midwest "Fifteenth Anniversary" catalog and see for yourself the many reasons why 110,000 satisfied customers bought their radios direct from the Midwest Laboratories and saved from 1/3 to 1/2. Why pay more than the direct-to-you laboratory price?

You, too, can make a positive saving of from 30% to 50% by buying this more economical way. Learn why Midwest outperforms sets costing up to \$200.00 and more. Never before so much radio for so little money! Midwest gives you triple protection with: One-year guarantee, foreign reception guarantee, money-back guarantee.

SENSATIONAL HIGH FIDELITY RECEPTION
This bigger, better, more powerful, clearer-toned, super-selective radio gives you absolute realism—assures you of life-like, crystal-clear tone—unlike anything you have ever experienced before! You will hear one more octave—over-tones—that cannot be brought in with ordinary radios. Now, hear every instrument, every voice, every shade and inflection of speech. Take advantage of the amazing 30-day FREE trial offer. Send coupon today for FREE catalog.

ALL FIVE WAVE BANDS

Only Midwest covers a tuning range of 9 to 2400 meters (33 Megacycles to 125 KC.)—enabling you to easily and successfully tune in foreign stations up to 12,000 miles away with crystal-clear, loud-speaker reception.

All 5 Wave Bands enable you to enjoy today's finest High Fidelity American programs.

In addition, you get Canadian, police, amateur, commercial, airplane and ship broadcasts and derive new delight and new excitement from unequalled world-wide broadcasts... England, France, Germany, Spain, Italy, Russia, Australia, etc. Send today for money-saving facts!

DEAL DIRECT WITH LABORATORIES

Increasing costs are sure to result in higher radio prices soon. Buy before the big advance... NOW... while you can take advantage of Midwest's sensational values... no middlemen's profits to pay. You can order your High Fidelity radio from the new Midwest catalog with as much certainty of satisfaction as if you were to select it in our great radio laboratories. You

**SAVE
UP TO
50%**

save 30% to 50% when you buy this popular way... you get 30 days FREE trial... as little as \$5.00 down puts a Midwest radio in your home. Satisfaction guaranteed or money back. Write for new FREE catalog.

NEW STYLE CONSOLES



The Midwest 36-page 1935 catalog pictures a complete line of beautiful, artistic deluxe consoles and chassis, in four colors. Write for new FREE catalog today!

Midwest long-range radios are priced as low as **\$27.50**

MIDWEST RADIO CORP.
DEPT. 793 — CINCINNATI, OHIO, U. S. A.

Established 1920

Cable Address Miraco... All Codes

50 ADVANCED 1935 FEATURES...
...and 16 tubes make this Super High Fidelity Radio today's most powerful long distance receiver. Its many exclusive features include: Micro-Tenator... Fidel-A-Stat... Separate Audio Generator... Ceramic Coil Forms, etc.

FEATURES OF NEW-TYPE MIDWEST DIAL

This dial takes the guesswork out of tuning. Now Midwest guarantees that inexperienced persons can secure good foreign reception. Send for FREE miniature of actual rotating dial—which clearly shows the advantages of these sensational features:

1. Dial calibrated in Kilocycles, Megacycles and Meters;
2. Call letters of American Broadcast Stations printed on dial and illuminated;
3. Slow-Fast, Smooth-Action Tuning;
4. Station Group Locator;
5. Simplified Tuning Guide Lights;
6. Automatic Select-O-Band Indicator;
7. Illuminated Pointer Indicator;
8. Silent Shadow Tuning—Improvement on Meter Tuning;
9. Centralized Tuning.

SEND NO MONEY!

**MAIL COUPON TODAY! FOR
AMAZING 30-DAY FREE TRIAL
OFFER AND NEW 1935 CATALOG**

MIDWEST RADIO CORP.,
Dept. 793,
Cincinnati, Ohio.

Without obligation on my part send me your new FREE 1935 catalog, FREE Miniature Dial, and complete details of your liberal 30-day FREE trial offer. This is NOT an order.

User-Agents
Make Easy
Extra Money

Check Here
for
Details

Name.....
Address.....
Town..... State.....